

# Congratulations!

Like thousands of Nomadic Display owners around the world, you now own the highest quality portable/modular display. Your Nomadic Instand is specially designed to give you the ultimate in versatility. Classic (curved) and Plus (straight) frame systems fully integrate to meet your growing exhibit demands. And your 100% satisfaction is guaranteed by Nomadic.

## The "No Questions Asked" Lifetime Warranty

Your Instand frame is guaranteed for life. If it ever fails to function — for any reason — Nomadic Display will repair it free of charge for as long as you own it. Be sure to complete and return the enclosed warranty card immediately.



## Safety Tested and Approved

Nomadic Instand® FabriColor backwalls, FabriCounters™ and Lights are listed by Underwriters Laboratories, Inc. or ETL, independent testing firms. The flame retardancy characteristics that apply to your display are indicated on the label affixed to the back of FabriColor panels.

Nomadic has recently been awarded the ISO9001 rating in the United Kingdom, providing further testimony to our commitment to producing premium quality products.



APPROVED TO BSEN ISO9001  
REG. N°: 9411001

## Made by Nomadic Display

Superior in design and strength, your Nomadic Display is built in Nomadic's own manufacturing plants in the U.S. and Ireland. We use only premium grade materials and take pride in maintaining the highest standards of craftsmanship. Your display is delivered to you packed for maximum protection and quick assembly.



## Nomadic Cares, Please Recycle

All Nomadic aluminum frames and cases can be recycled.

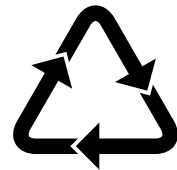

The Nomadic products described herein are protected by one or more of the following U.S. patents:

4,280,521	4,637,180	4,970,841
4,512,097	4,747,239	D 330294
4,522,008	4,800,663	
4,561,618	5,044,595	

Other U.S. patents pending. International patents granted and pending.

Nomadic  Display®

# Setting Up Your Display is as Easy as 1-2-3

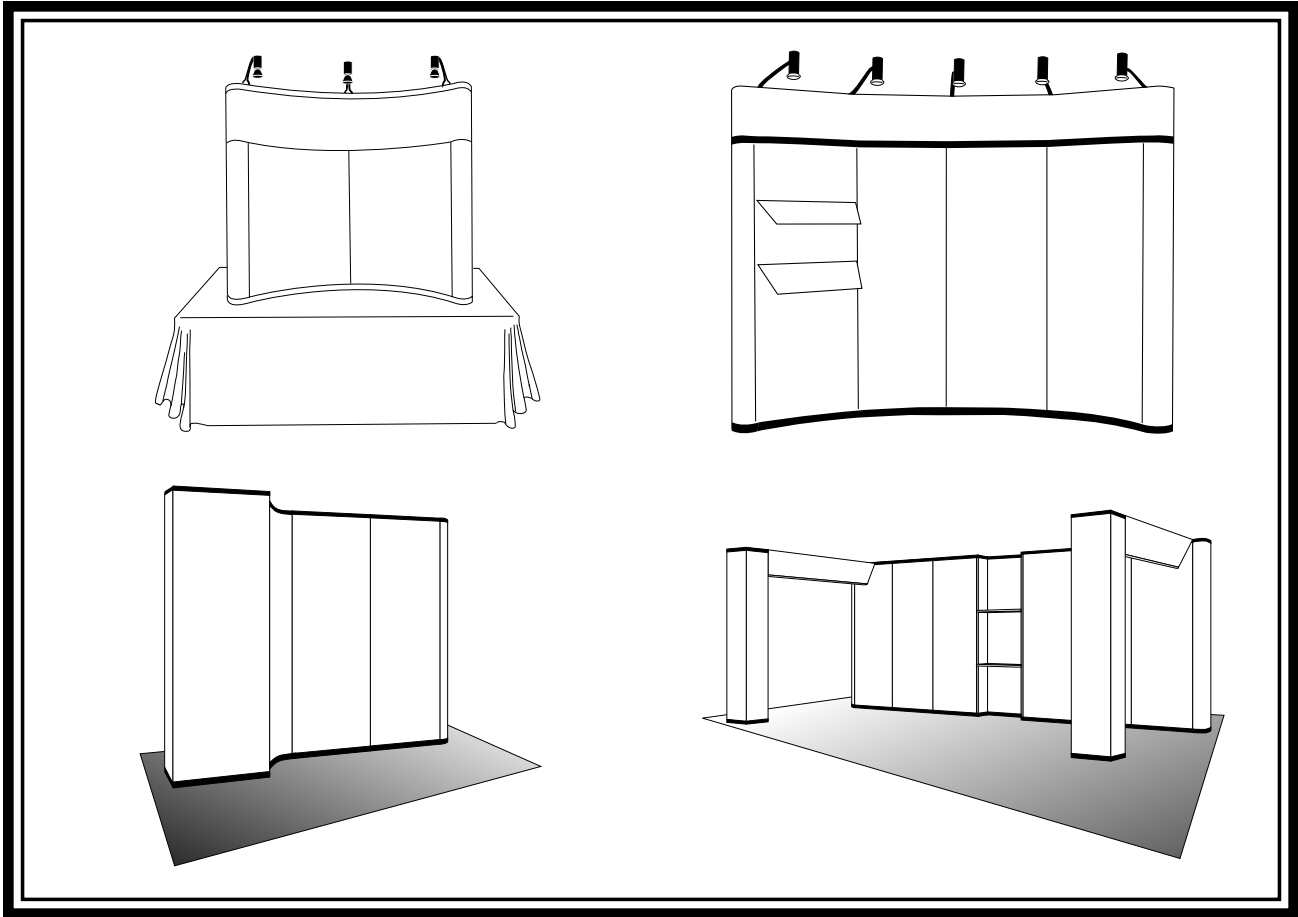

We recommend that you assemble and repack your display prior to your first event. It is important to follow each step in the order indicated. If you need additional assistance or have any questions, please call your nearest Nomadic LifeLine:

**North America:**  
1-800-732-9395

**Ireland/Europe:**  
+ 353-98-66011 (Day)  
+ 353-1-283-0800 (Evening)  
Ask for call sign "Nomadic"

**United Kingdom:**  
0399-734215  
**Germany:**  
0180-2304311

## Proper Care & Maintenance of your Nomadic Display

- Store display upright at room temperature
- Do not subject to extreme heat or cold
- Do not leave display in direct sunlight or trunk of auto
- Return display to room temperature before handling
- Avoid extreme bending of Panels or permanent creasing will occur
- Use fabric brush to remove dust from FabriColor Panels

# Table of Contents

<b>QUICK SET UP</b> .....	<b>6</b>
<b>CASES</b> .....	<b>8</b>
Rolluxe .....	8
RollEase, ShowMate, Cylindrical .....	10
<b>FRAMES</b> .....	<b>11</b>
Glossary of System Components .....	11
Frame Set Up: Instand Classic and Plus .....	12
Connected Strut .....	13
Frame Connection: Hinged Connected Strut, Plus to Plus Connecting Scissor .....	14
Frame Connection: Plus to Plus Wing Offset Connecting Scissor .....	15
Frame Connection: Plus to Plus Connecting Rod, Plus to Classic Connecting Rod .....	15
<b>PANELS AND END CAPS</b> .....	<b>16</b>
Glossary of Panels .....	16
Panels.....	17
<b>LIGHTING</b> .....	<b>18</b>
Light Box .....	18
HeadLiner .....	20
Plus HeadLiner .....	21
Sconce Light .....	22
<b>FRAME EXTENSIONS</b> .....	<b>23</b>
Column/Slim Wing, Tower .....	23
Bridge: Square .....	24
Bridge: Triangular .....	25
Bridge: Bridge Brace.....	27
Bridge Hanging and Backlighting .....	29
Extended Quad .....	30
<b>SHELVING</b> .....	<b>31</b>
External Shelf, Waterfall Bracket.....	31
Plus One Quad ShowCase, Pass Through Box .....	32
Plus One and a Half or Two Quad ShowCase .....	34
ShowCase Accessories: Adjustable Acrylic Shelf, RollUp Window, Extension Bracket.....	36
Monitor Shelf .....	37
<b>COUNTERS AND TABLES</b> .....	<b>38</b>
DemiTable.....	38
Peninsula Table .....	39
Rolluxe Pedestal .....	40
Rolluxe Counter.....	41
RollEase Counter .....	42
FabriCounter .....	43
Lectern .....	44
<b>REPACKING</b> .....	<b>45</b>

# Setting Up Your Display is as Easy as 1-2-3

## Opening Your Case:

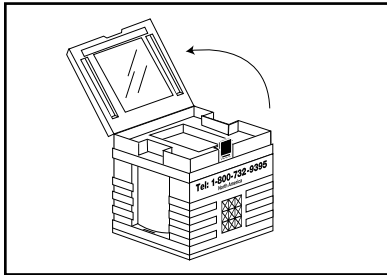

**Rolluxe Case:** To open lid set your combination at "000" or your own personal combination. For instructions on setting a new combination, refer to the case section of this guide.

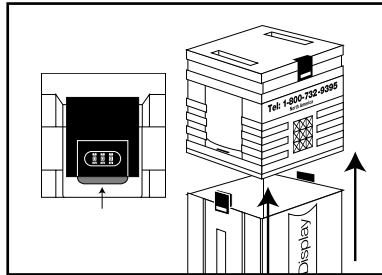

Press red button and lift latch to release side latches and remove the top.

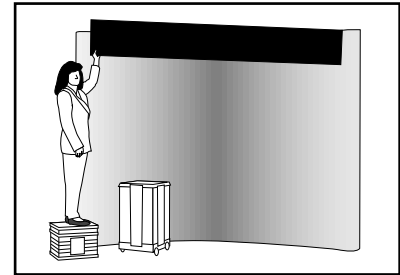

Rolluxe Case top serves as a built-in step stool to facilitate hanging and adjusting lights or graphics.

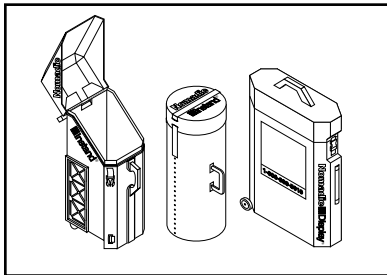

**RollEase, Cylindrical or ShowMate Case:** Unlatch the buckles and lift off the lid for easy unpacking.

## REMEMBER –

Read the complete instructions about your Instand product before assembling. If you need additional assistance or have any questions, please call the nearest Nomadic LifeLine.

## Setting Up Your Instand Frame:



Place frame with red studs facing front.

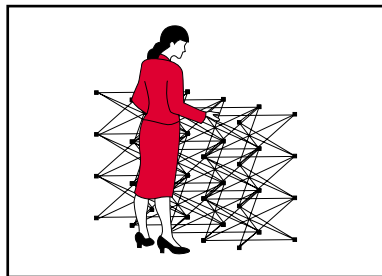

Grasp two top center hubs and lift frame open to shoulder height. Handle frame at hubs only.

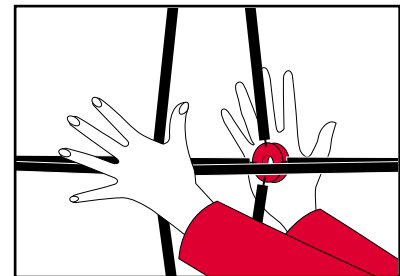

Press front and back hubs in the center of the frame until Instand locks into position. (Front and back hubs do not meet.)\*

**\*Note:** Once frame is expanded, the row of red hubs (or red studs) should be on the floor facing forward.

# Setting Up Your Display is as Easy as 1-2-3

*Instand Lights are UL or ETL approved*

## Covering Your Instand with Fabric or Graphics:

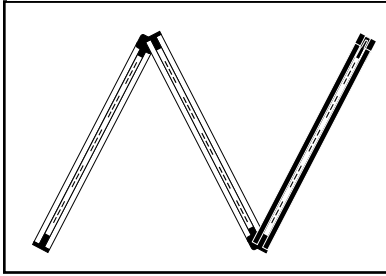

Unfold connected strut . . .

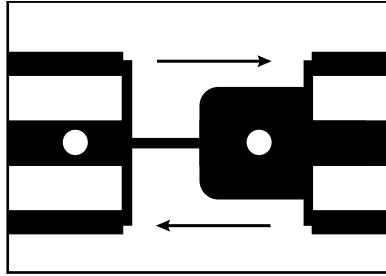

. . .and connect bottom two sections by joining as illustrated.

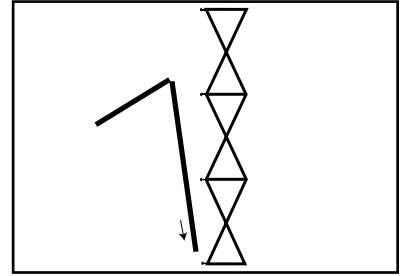

Slide bottom of connected strut onto the red stud at the bottom of the frame.

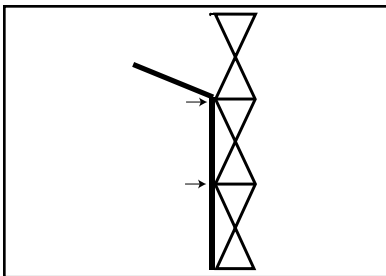

Snap next two connectors onto studs on frame.

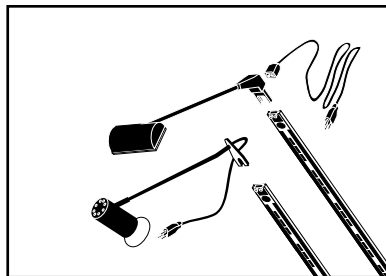

Attach lights to top of struts. Swivel fixtures to adjust position. Run cord behind display.

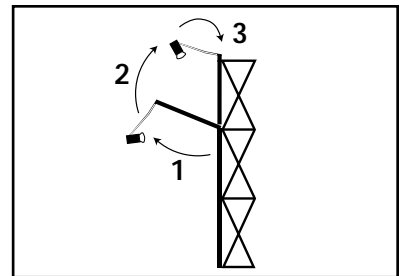

Rotate top section of strut up and slide down onto top stud.

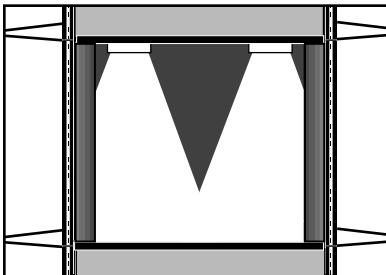

Install ShowCases, external shelf brackets and bridge braces before hanging fabric. For detailed instructions on ShowCases or external shelves, refer to the shelving section of this guide.

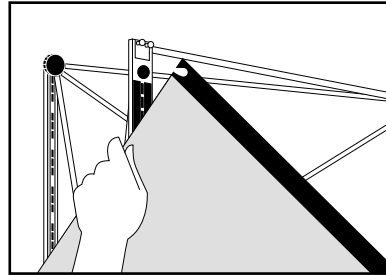

Hang all top panels and full size panels first. Lift onto studs atop frame. Hook one side then the other. Gradually release downward to bond magnets.

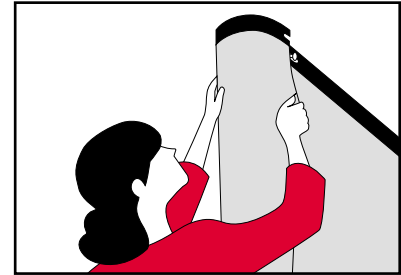

For end caps and connecting panels bow panel. Lift onto studs atop front and back sides of frame. For hinged panels hook one side and then the other. Slide hands along length of panel to bond magnets.



To hang top panels for ShowCases or light boxes, gradually release downward to bond magnets. Tuck bottom edge of top fabric panel into lip of shelf. To hang bottom panels, tuck fabric under shelf first.

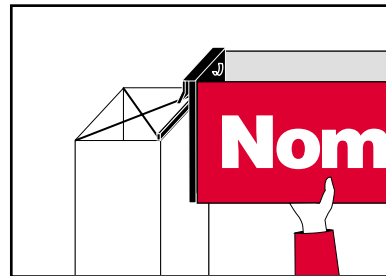

Install bridges between two displays or a display and a column on bridge braces. For detailed instructions on bridges, refer to the frame extensions section of this guide.



Hang headers, HeadLiner, or Velcro® graphics last. For detailed instructions on HeadLiner, refer to the lighting section of this guide.

Nomadic  Display®

# Rolluxe Case

## To remove top and set a new combination

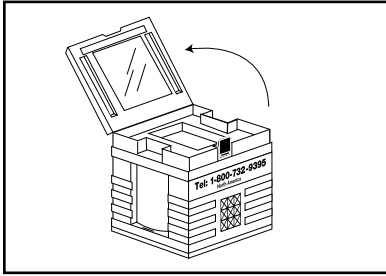

To open lid set your combination at "000". To set your own personalized combination...

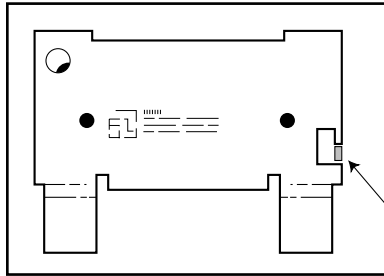

... look at the back of the lock between the latch and the case to locate the silver change lever.

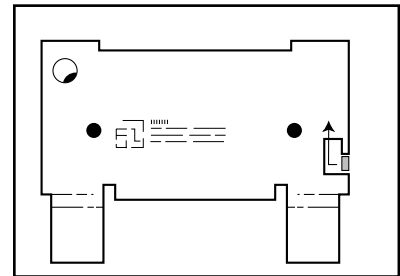

Use a hard object such as the back of a key to push the silver change lever in towards the center of the lock and then up towards the lid.

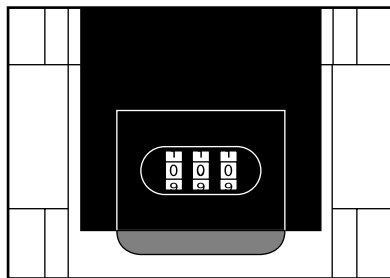

Set your personal combination by turning the dials downward on the front of the lock.

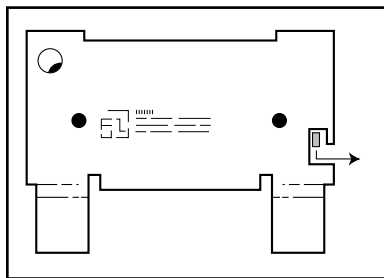

Return the silver change lever to its original position. Your personalized combination is now set.

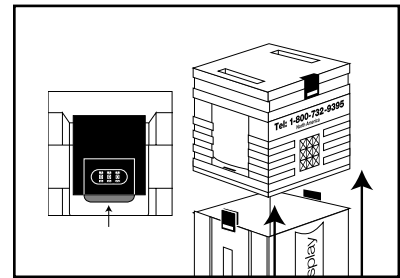

Press red button to release side latches and remove the top.  
**Note:** You may want to change all combinations to match.

## REMEMBER –

Write your personalized combination down for your records and provide it to your I&D company prior to shipping the display.

# Rolluxe Case (cont.)

## To use built-in step stool

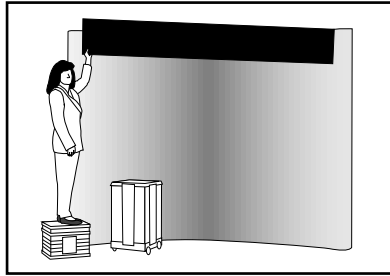

Rolluxe Case top serves as a built-in step stool to facilitate hanging graphics.

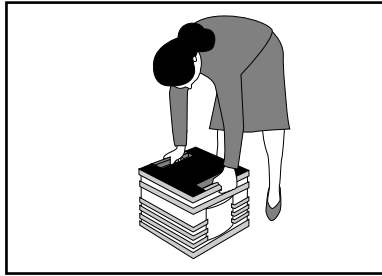

Make sure that step stool is on flat and level floor.



Do not wear high heels while standing on step stool.

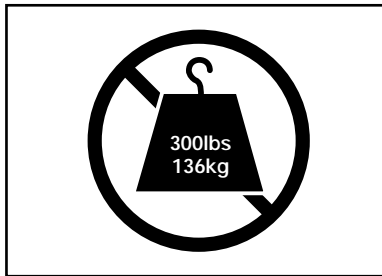

Do not place more than 300 lbs / 136 kg on step stool.



Step stool surface may be slippery when wet.

## To close and move Rolluxe Case

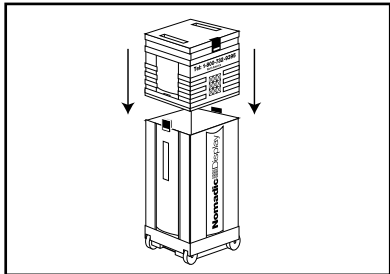

Align handle with wheels, snap and lock exterior latches. Scroll down the combination locks.

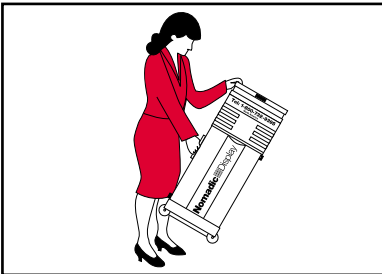

Grip top handle with one hand and the retractable handle with the other to lift case. Remember to always bend your knees.

# RollEase, ShowMate and Cylindrical Cases

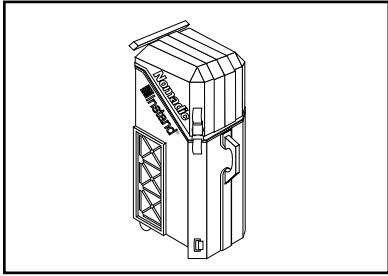

RollEase Case

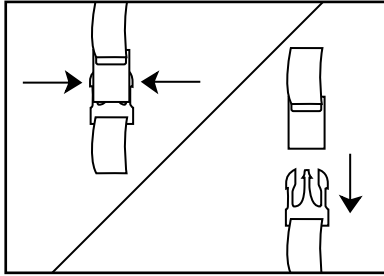

Push in on the tabs on either side of the buckle and pull apart.

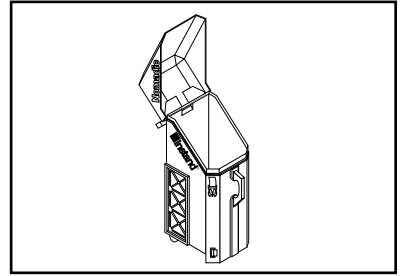

Raise lid to unpack contents.

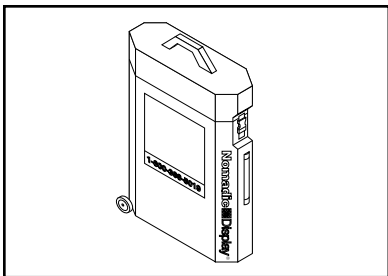

ShowMate Case

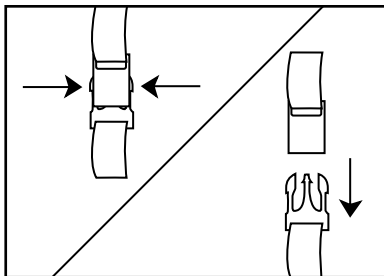

Push in on the tabs on either side of the buckle and pull apart.

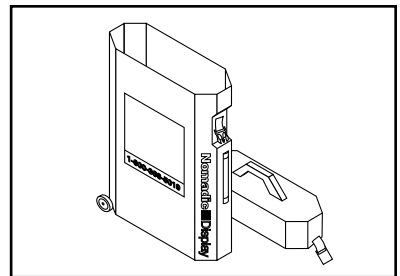

Pull off lid to unpack contents.

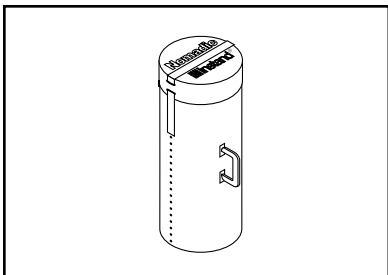

Cylindrical Case

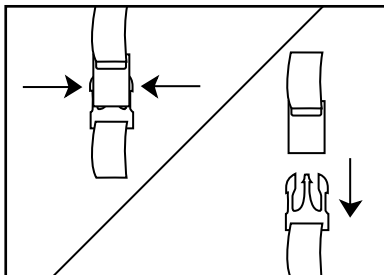

Push in on the tabs on either side of the buckle and pull apart.

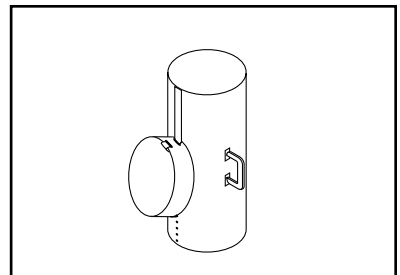

Pull off lid to unpack contents.



# Glossary of System Components

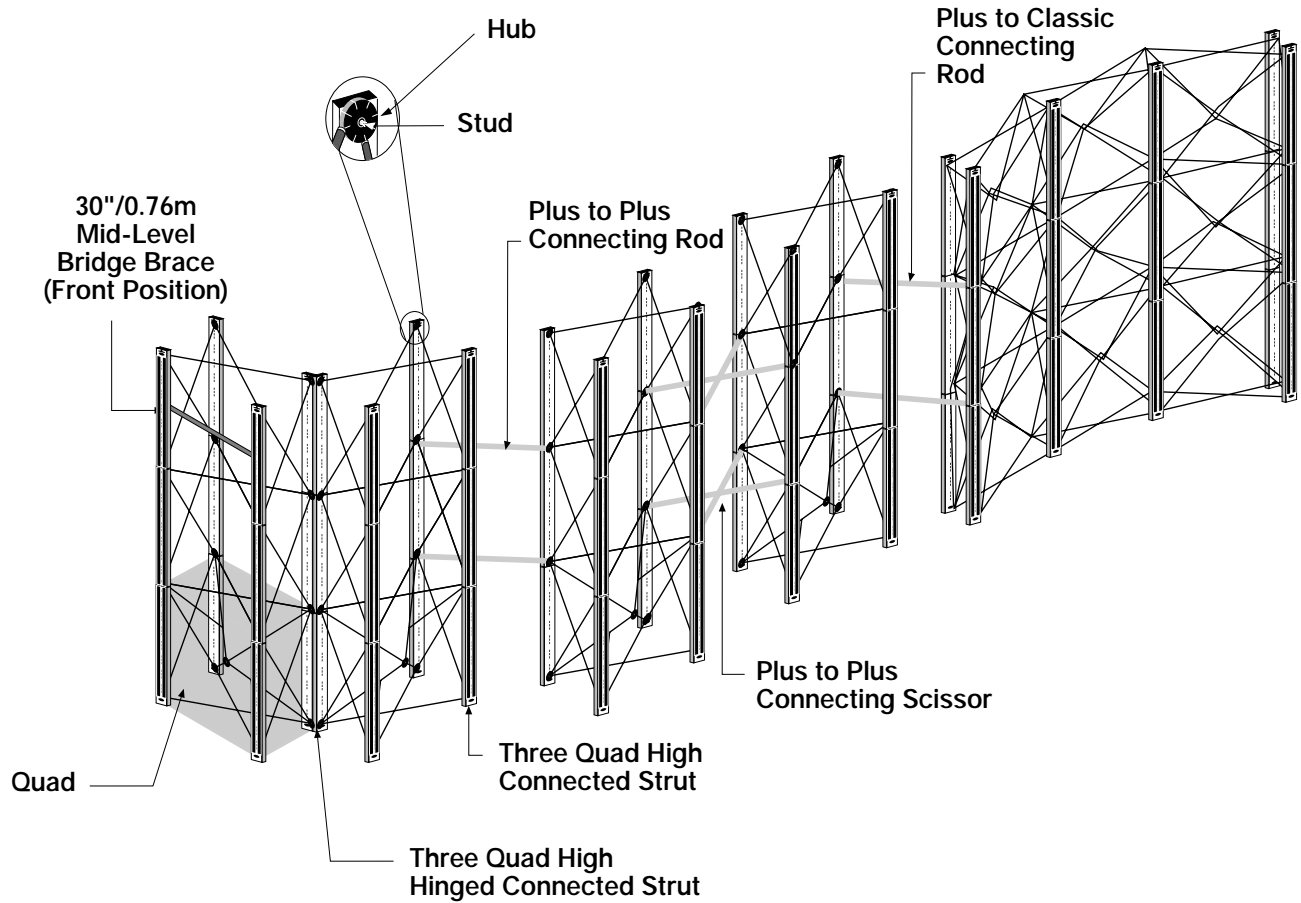

# Frame Set Up

Instand Classic Frames come in different sizes:

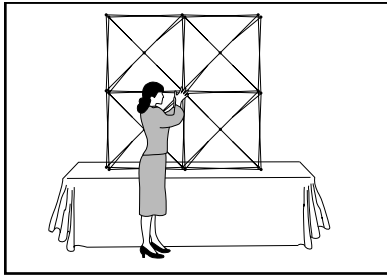

**2x2 Classic Frame**  
5'x5' / 1.5 x1.5m

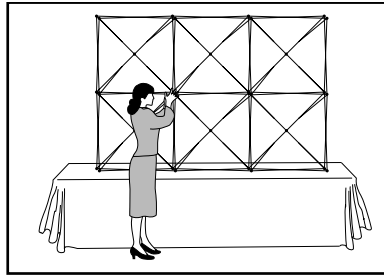

**2x3 Classic Frame**  
5'x8' / 1.5x2.4m

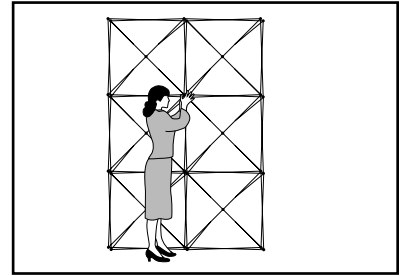

**3x2 Classic Frame**  
8'x5' / 2.4x1.5m

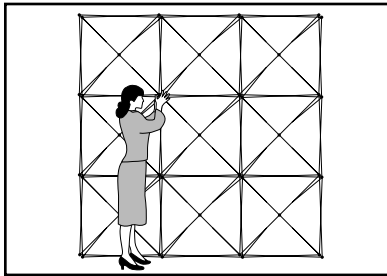

**3x3 Classic Frame**  
8'x8' / 2.4x2.4m

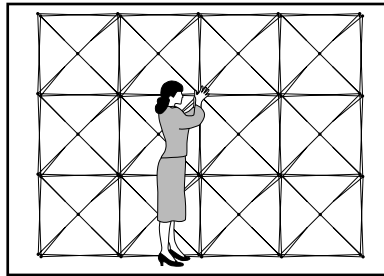

**3x4 Classic Frame**  
8'x10' / 2.4x3.0m

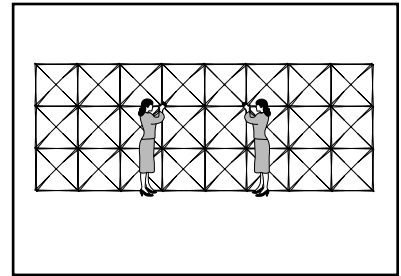

**3x8 Classic Frame**  
8'x20' / 2.4x6.0m

Instand Plus Frames come in different sizes:

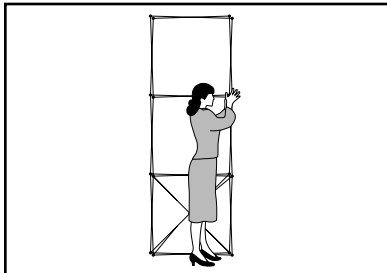

**3x1 Plus Frame**  
or **3x1 Plus Wing Frame**  
8'x2.5' / 2.4x0.8m

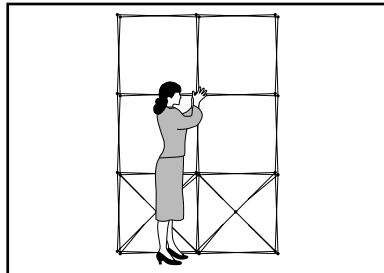

**3x2 Plus Frame**  
8'x5' / 2.4x1.6m

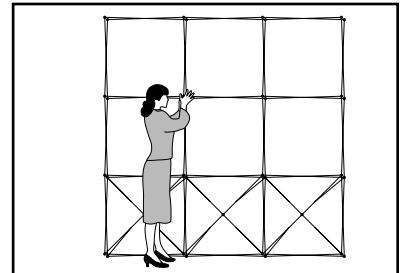

**3x3 Plus Frame**  
8'x8' / 2.4x2.4m

All Instand Frames set-up the same way:



Place frame on floor with red studs facing front.

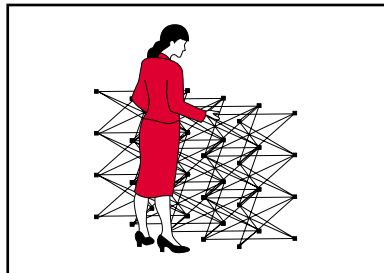

Grasp two center hubs and lift frame open to shoulder height. Handle frame at hubs.

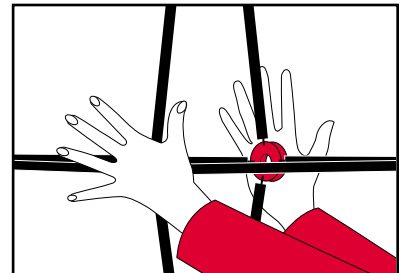

Press front and back hubs in the center of the frame until Instand locks into position. (Front and back hubs do not meet.)\*

\*Note: Once frame is expanded, the row of red hubs (or red studs) should be on the floor facing forward.

# Connected Struts with or without Lights

*Instand Lights are UL or ETL approved*

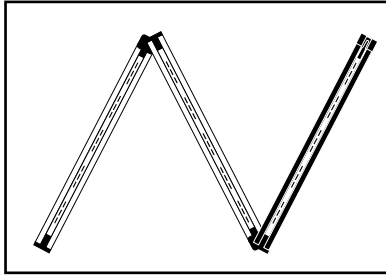

Unfold connected strut . . .

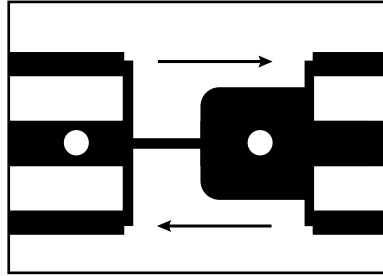

...and connect bottom two sections by joining as illustrated.

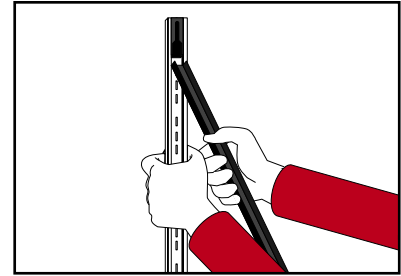

If using Blackout Strips, insert by starting at the top of the strut section...

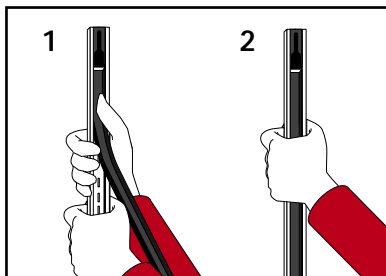

...and using thumbs press strip into back of the strut section. Continue pushing into strut until entire strut section is covered. Repeat for each section of strut.

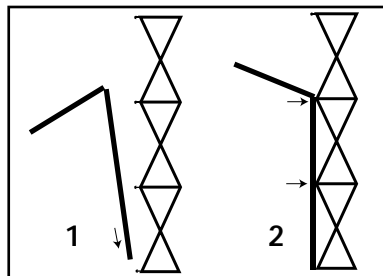

Slide bottom of connected strut onto the stud at the bottom of the frame. Snap next two connectors onto studs on frame.

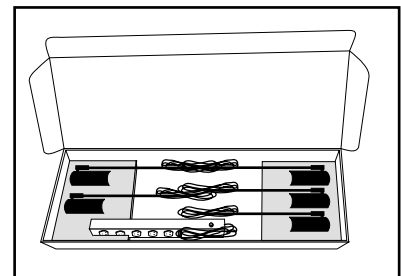

Unpack lights and ElectroStrut from the carton.

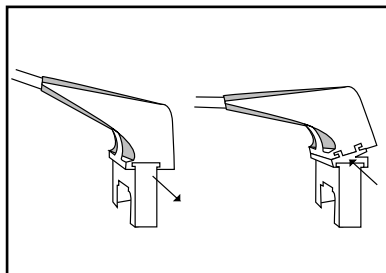

For low ceiling environments, remove sleeve connector and replace with Low Ceiling Mounting Clip.

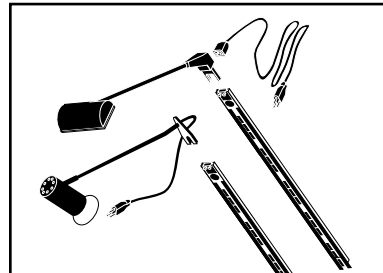

Attach lights to top of struts. Swivel fixtures to adjust position. Run cord behind display.

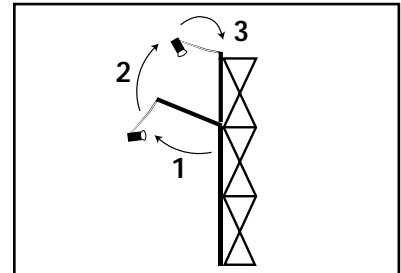

Rotate top section of strut up and slide down onto top stud.

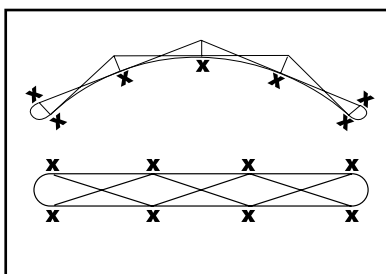

Attach struts to front and rear sides of curved frames. Attach struts to front and rear of straight frames.

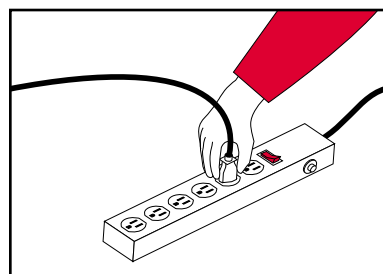

Plug light cords into ElectroStrut power outlet strip. Use power switch to turn all lights on and off.

**CAUTION –**  
Fixtures become hot with use — handle with care.

In North America order 5 amps of single phase 120v electrical service for your Light Set.  
In Europe order 5 amps of Double phase 220 - 240v electrical service for your Light Set.

# Frame Connection

## (A) Hinged Connected Strut

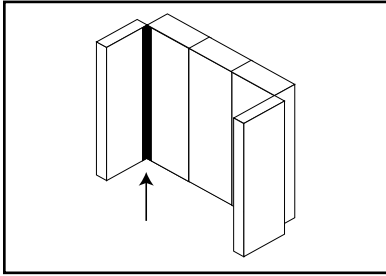

Hinged connected struts connect any two Instand frames.

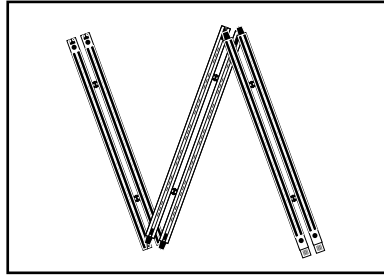

Unfold hinged connected struts. Lay flat on the floor.

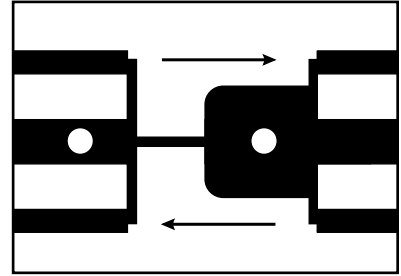

Connect separate sections by joining as illustrated.

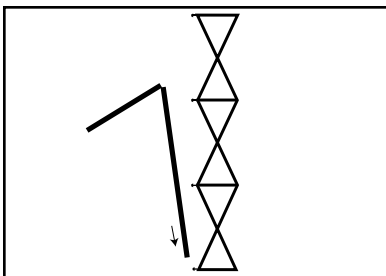

Place frames side-by-side (*red studs face front*). Slide bottom of struts onto the studs at the bottom of the frames.

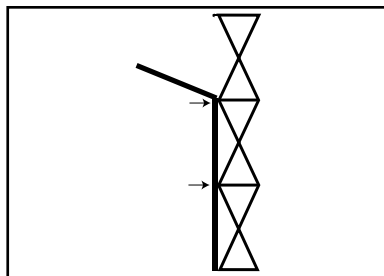

Snap next two connectors onto frames.

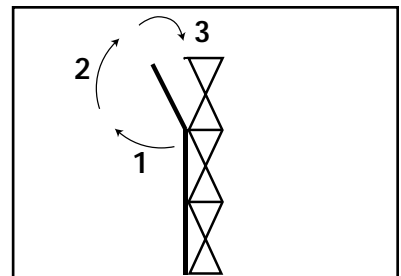

Rotate top section of strut up and slide down onto top stud.

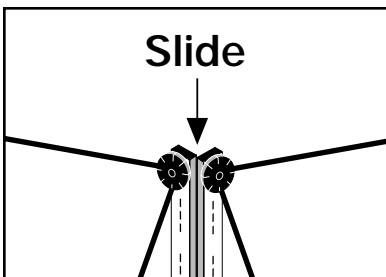

Attach hinged fabric filler panel to hinged strut.

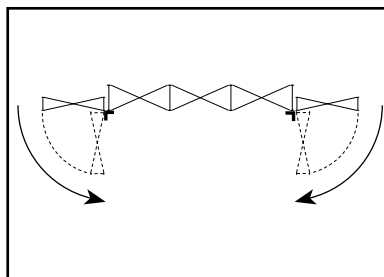

Swing frame into desired position.

## (B) Plus to Plus Connecting Scissor

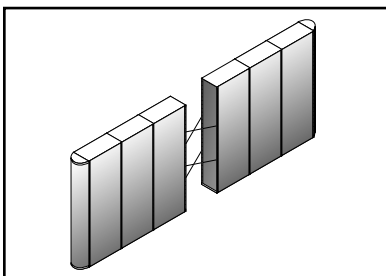

Plus to plus connecting scissors connect frames side by side.

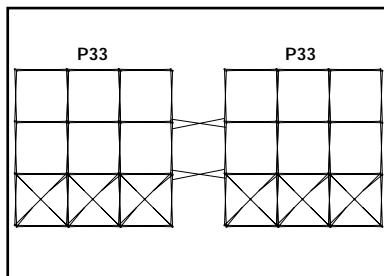

Place frames side-by-side and unfold connecting scissors carefully.

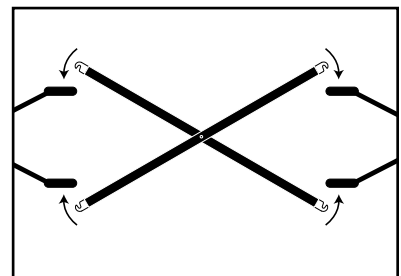

Slide hooked blade ends of connecting scissor into slots located in front and back hubs.

# Frame Connection (cont.)

## (C) Plus to Plus Wing Offset Connecting Scissor

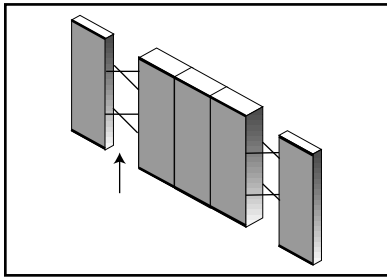

Plus to plus wing offset connecting scissors connect frames of different depths side by side. (i.e. P33 to P13W)

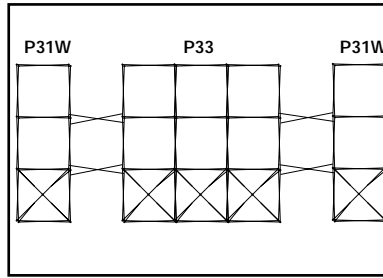

Place frames side-by-side and unfold offset scissors carefully. Attach offset scissors for each frame connection.

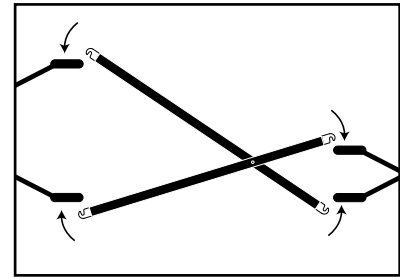

Slide hooked blade ends of offset scissors into slots located in front and back hubs.

## (D) Plus to Plus Connecting Rod

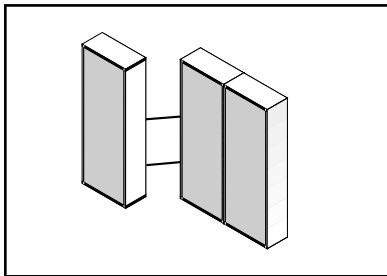

Plus to plus connecting rods connect frames at an angle. Attach 2 connecting rods from rear hubs of one frame to rear hubs of second frame.

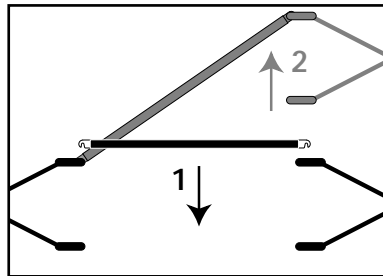

Place frames side-by-side.  
 (1) Slide hook end of connecting rod into slot located in back of hub.  
 (2) Push one frame back.

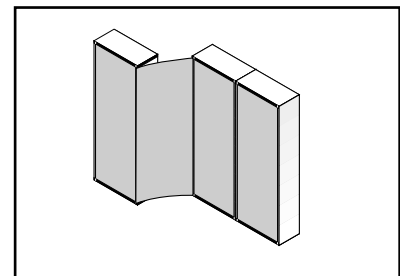

Hang large connecting fabric panel between frames.

## (E) Plus to Classic Connecting Rod

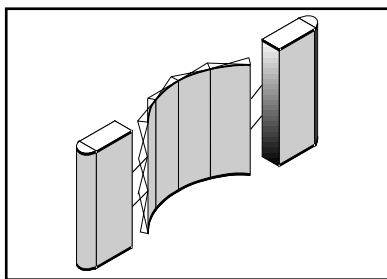

Plus to classic connecting rods connect plus and classic frames in a straight line. Attach 2 connecting rods for each frame.

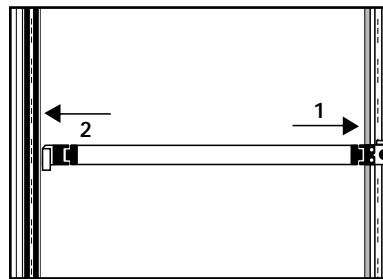

Place frames side-by-side. Slide lip of connecting rod onto connected strut to the back of the connected strut at the back of the plus frame and the front of the classic frame. Hold into place while tightening down knobs at each end of the connection.

**CAUTION –**  
 Some parts on scissors and rods may be sharp; please handle with care.

# Glossary of Panels

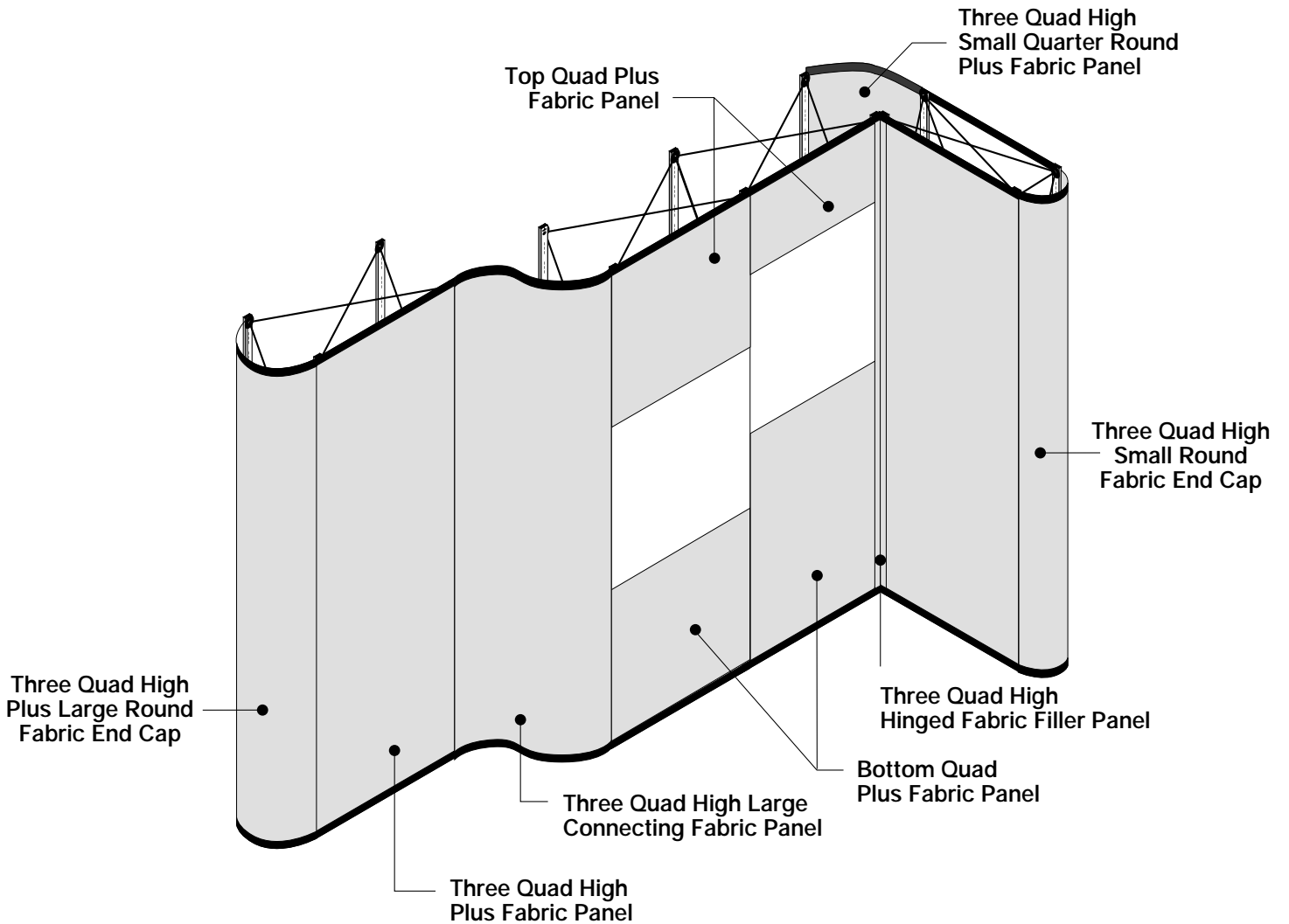

**NOTE:** Plus panels have metal bars on the back at the top and bottom. Classic panels have no bar.

# Panels

See labels affixed to back of panels for placement

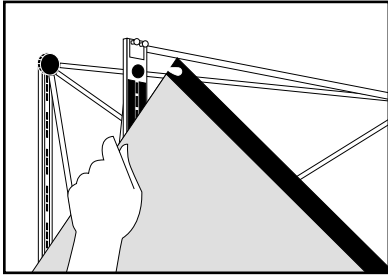

Hang all top panels and full size panels first. Lift onto studs atop frame. Hook one side then the other. Gradually release downward to bond magnets.

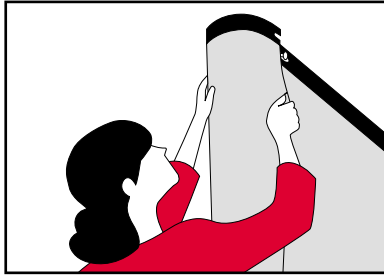

Bow end cap and quarter round panel. Lift onto studs atop front and back sides of frame. Slide hands along length of panel to bond magnets.



Hang hinged panels onto studs at top of frame. Hook one side then the other. Slide hands along length of panel to bond magnets.

## For top and bottom panels

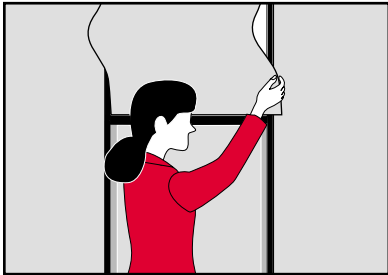

Gradually release downward to bond magnets. Tuck bottom edge of top fabric panel into lip of shelf.

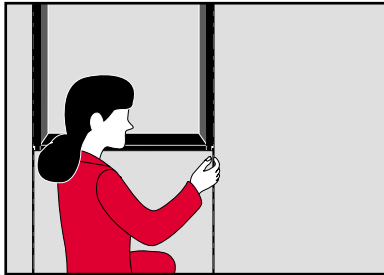

Slide bottom fabric panel up under lip of shelf or counter. Align to bottom edges of fabric.

# Light Box

*Fluorescent Lights are UL or ETL approved*

Classic frames accept backlighting in limited quantities in shaded quads:

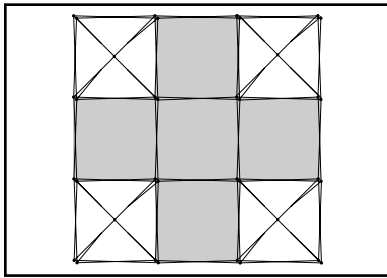

8'x8' / 2.4x2.4m

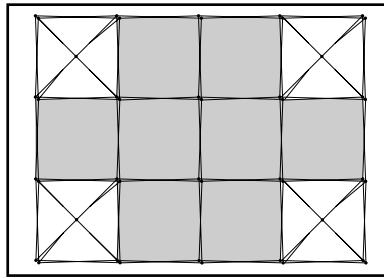

8'x10' / 2.4x3.0m

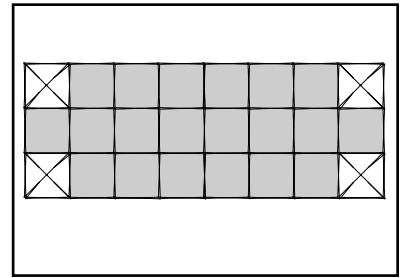

8'x20' / 2.4x6.0m

To install this accessory your classic frame must be manufactured without crossbracing in the quad.

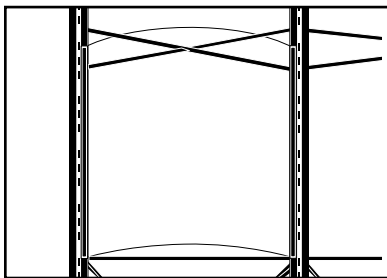

Insert one-piece quad level light box reflector panel inside quad without crossbracing. Wrap edges onto front magnets.

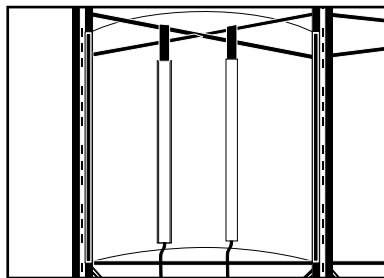

Suspend fluorescent lights from back scissor above the quad.

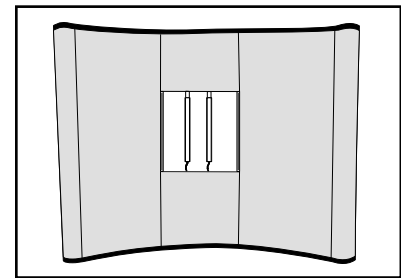

Hang panels before attaching transparency.

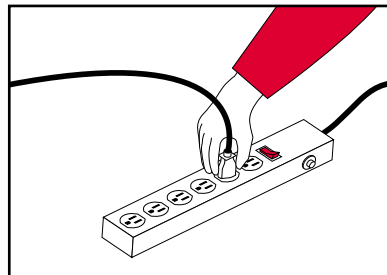

Plug light cords into ElectroStrut power outlet strip. Use power switch to turn all lights on and off.

In North America  
order 1 amp of single phase  
120v electrical service for  
every 4 Fluorescent Lights.



# Light Box (Cont.)

*Fluorescent Lights are UL or ETL approved*

Plus frames accept backlighting in any quad:

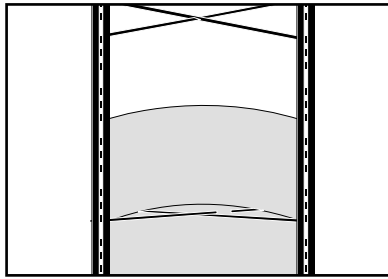

**Eye Level Installation** — Insert one half of eye level light box reflector panel above scissor and other half below the scissor. Wrap edges onto front magnets.

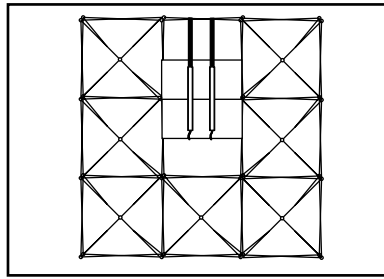

Suspend fluorescent lights from back scissor at top of frame.

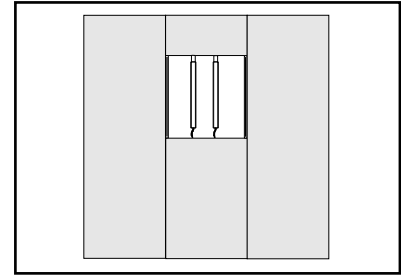

Hang panels before attaching transparency.

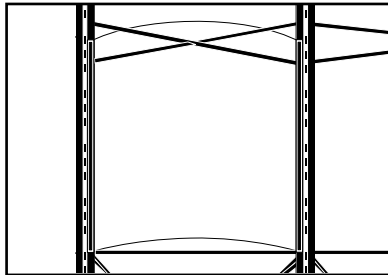

**Quad Level Installation** — Insert one-piece quad level light box reflector panel inside quad. Wrap edges onto front magnets.

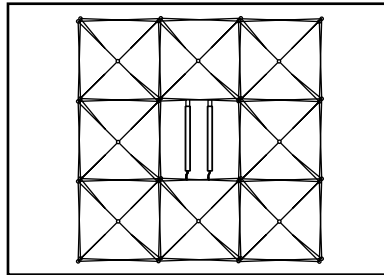

Suspend fluorescent lights from back scissors above each quad.

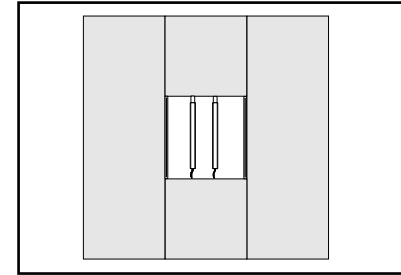

Hang panels before attaching transparency.

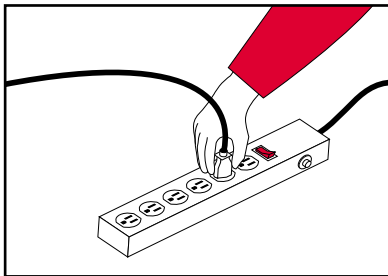

Plug light cords into ElectroStrut power outlet strip. Use power switch to turn all lights on and off.

In North America  
order 1 amp of single phase  
120v electrical service for  
every 4 Fluorescent Lights.

# HeadLiner\*

*HeadLiner electrical components are UL or ETL approved*

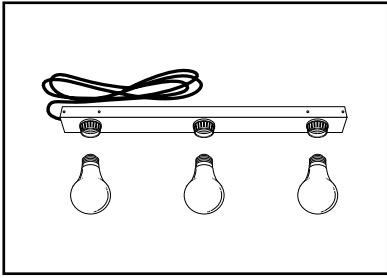

Remove HeadLiner light bars from light box. Insert bulbs into sockets.

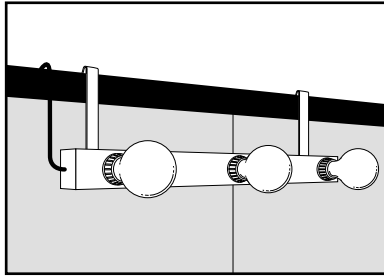

Center light bars. Drape cords behind display. Plug light cords into ElectroStrut power outlet strip at the back of the frame.

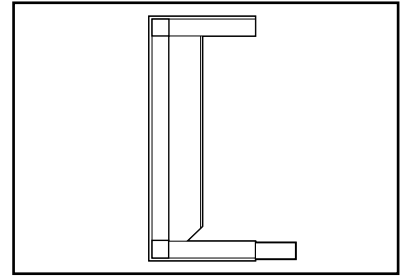

Remove end pieces from box.

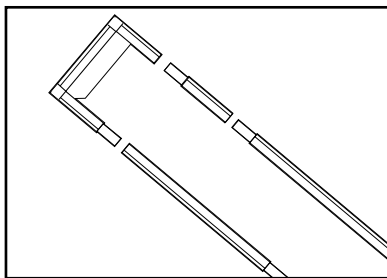

Lay end pieces opposite each other. Place segments in between, all ends should match up male to female.

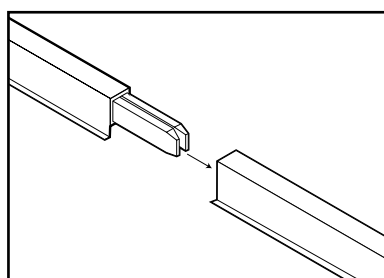

Starting with an end piece connect all pieces together.

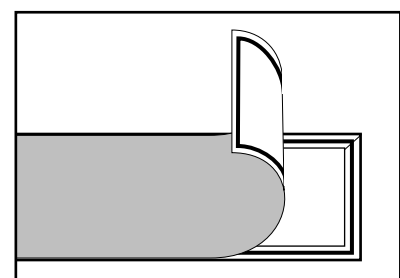

Unroll graphics and attach to front of HeadLiner frame. Press to adhere Velcro ends.



Hang HeadLiner on Classic frame by brackets. Lift and hook one side on first, then the other.

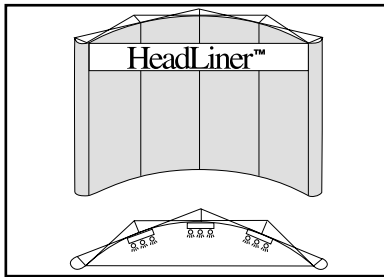

Position HeadLiner on Classic frame so edges align at seam along end cap.

**CAUTION –**  
**Fixtures become hot with use — do not place too close to HeadLiner.**

In North America order 5 Amps of single phase 120v electrical service for HeadLiner.

\*For use with 5'x8'/1.5x2.4m, 8'x8'/2.4x2.4m, 8'x10'/2.4x3.0m Classic Frames.

75 Watt standard bulb replacements are available at most lighting and hardware stores.

# Plus HeadLiner Instructions

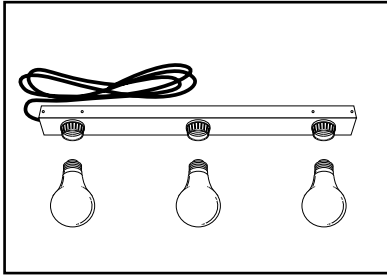

Remove HeadLiner light bars from light box. Insert bulbs into sockets.

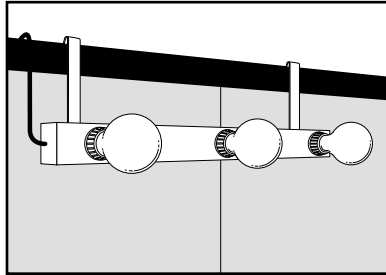

Center light bars. Drape cords behind display. Plug light cords into ElectroStrut power outlet strip at the back of the frame.

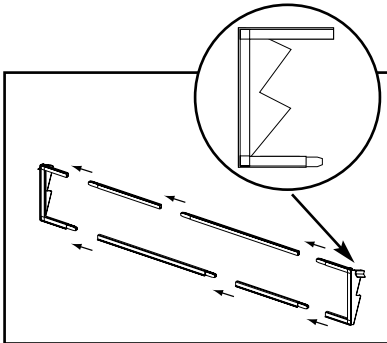
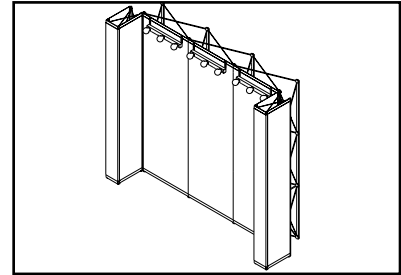

Remove end pieces from box. Lay end pieces opposite each other. Place segments in between, all ends should match up male to female.

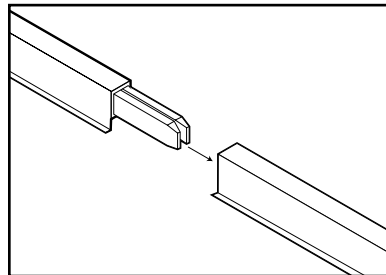

Starting with an end piece connect all pieces together.

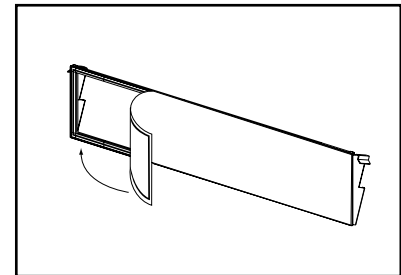

Unroll graphics and attach to front of HeadLiner frame. Press to adhere Velcro® ends.

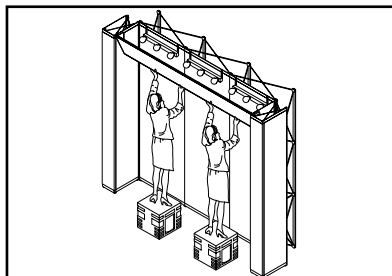

Hang the Plus HeadLiner frame by the brackets. We recommend that two people lift and hang the HeadLiner.

**CAUTION –**  
Fixtures become hot with use.

In North America order 5 Amps of single phase 120v electrical service for HeadLiner.

# Sconce Light

*Sconce Light electrical components are UL or ETL approved*

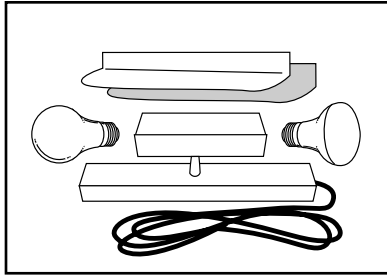

Remove sconce light bar and brackets from light box. Insert bulbs into sockets.

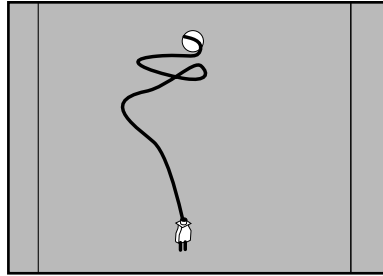

Cut a hole in the fabric panel large enough for the light cord, and push it through.

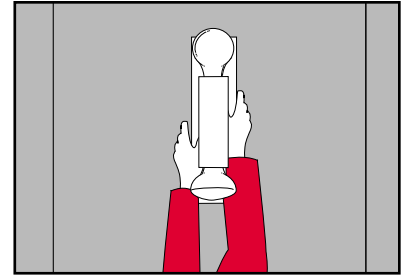

Press sconce light bar into place with reflector bulb down.

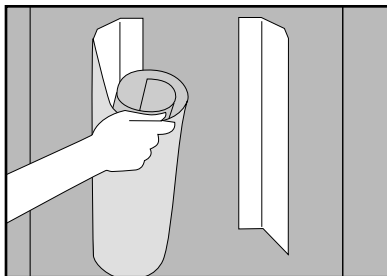

Attach graphic to one bracket. Unroll graphic and attach to opposite bracket. Press graphic into place.

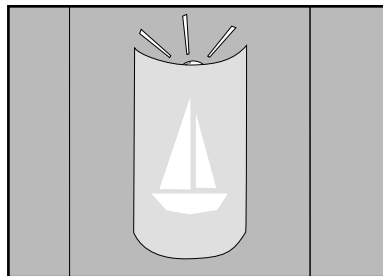

Press brackets with graphic attached into position at either side of sconce light.

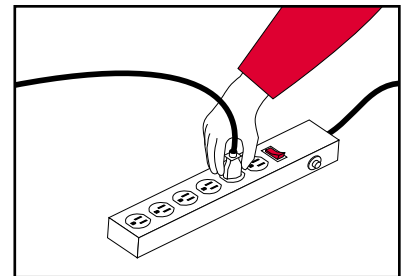

Plug light cord into ElectroStrut power outlet strip. Use power switch to turn all lights on and off.

**CAUTION –**  
Fixtures become hot with use — handle with care.

In North America order 3 Amps of single phase 120v electrical service for 2 Sconce Lights

75 Watt standard bulbs and 50 Watt reflector bulbs are available at most lighting and hardware stores.

# Columns and Towers

## Column/Slim Wing

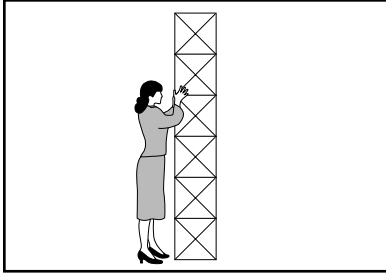

6 x 1 Column frame or  
Slim Wing frame  
8'x16" / 2.4 x 0.4m

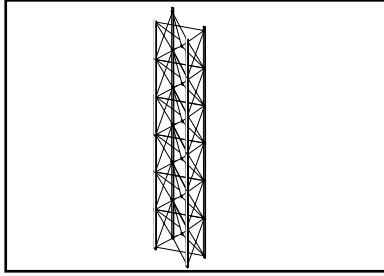

Attach connected struts on entire system.

See next page for instructions to add a bridge.

## Tower

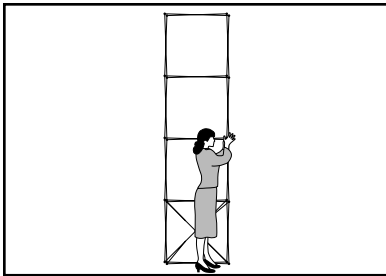

4 x 1 Plus frame or  
Plus Wing frame  
10'x30" / 3 x 0.8m

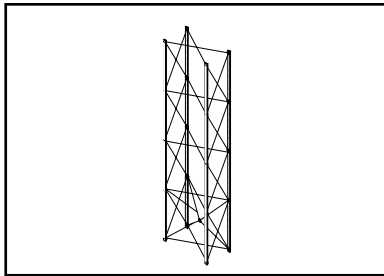

Attach connected struts on entire system.

See next page for instructions to add a bridge.

## Back-to-Back Tower

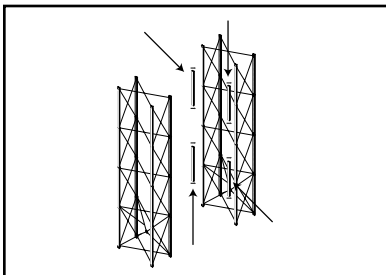

Attach connected struts to two tower frames. Place 4 spacer bars in between the two frames.

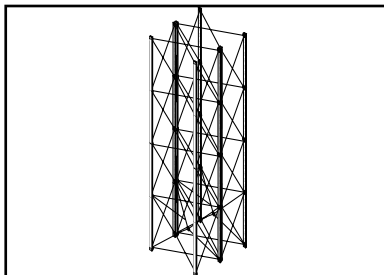

Press frames together to form tower.

See next page for instructions to add a bridge.

# Square Bridge Instructions

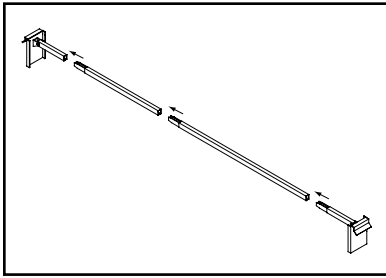

Line up bridge bar modules end to end, then connect them.

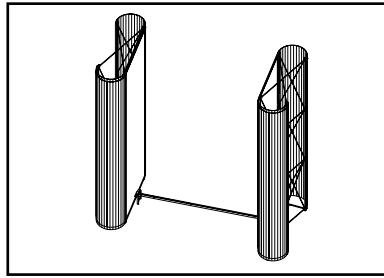

Lay the bridge bar between the two frames to properly space them apart.

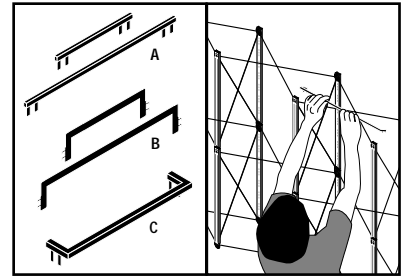

Insert the 15"/0.38m or 30"/0.76m bridge brace (either configuration A, B or C) securely into the slots at the top of the connected struts.

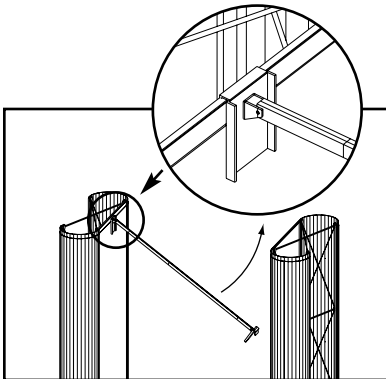

Hook one end of the bridge bar on a bridge brace then swing the other end into position and hook it into place.

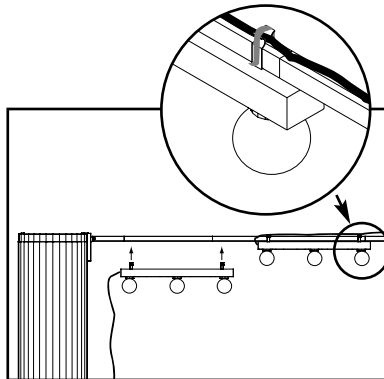

If using a bridge with backlighting, attach lights by pushing up so that the U connectors snaps around the light bar. Use the Velcro® straps to fasten the power cords along the length of the bar.

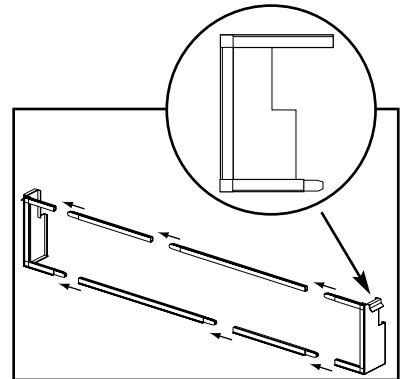

Remove end pieces from box. Lay end pieces opposite each other. Place segments in between, all ends should match up male to female.

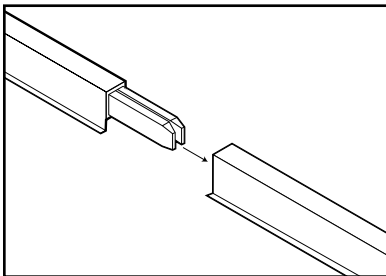

Starting with an end piece connect all pieces together.

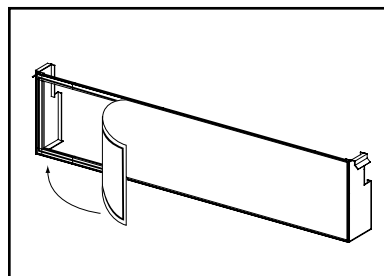

Unroll graphics and attach to front of bridge frame. Press to adhere Velcro ends.

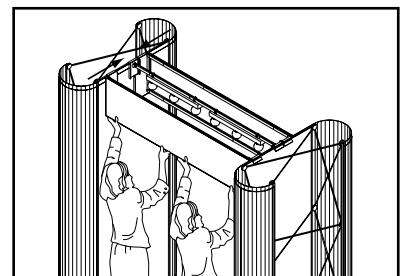

We recommend that two people lift and hang each half of the bridge. Hook bridge on bridge braces. Slide both halves of the bridge together and press to adhere Velcro edges.

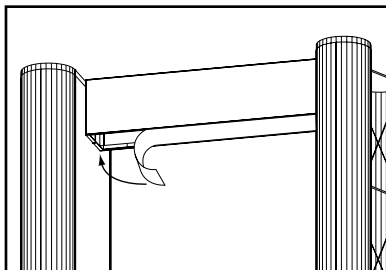

Attach the diffuser panel to the underside of the bridge. Press to adhere Velcro ends.

# Triangular Bridge Instructions

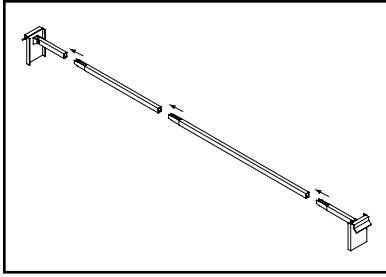

Line up bridge bar modules end to end, then connect them.

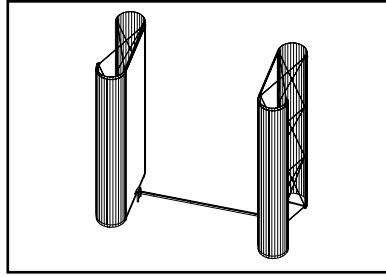

Lay the bridge bar between the two frames to properly space them apart.

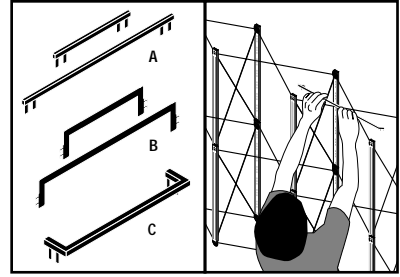

Insert the 15"/0.38m or 30"/0.76m bridge brace (either configuration A, B or C) securely into the slots at the top of the connected struts.

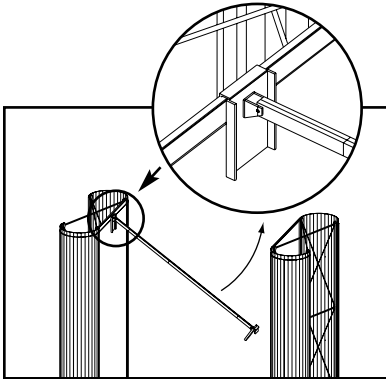

Hook one end of the bridge bar on a bridge brace then swing the other end into position and hook it into place.

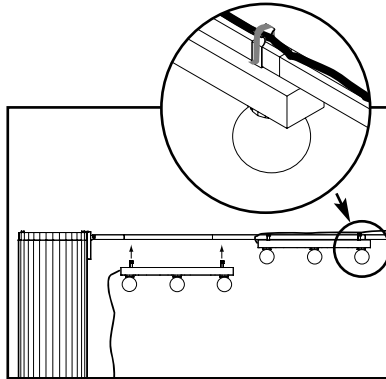

If using a bridge with backlighting, attach lights by pushing up so that the U connectors snaps around the light bar. Use the Velcro® straps to fasten the power cords along the length of the bar.

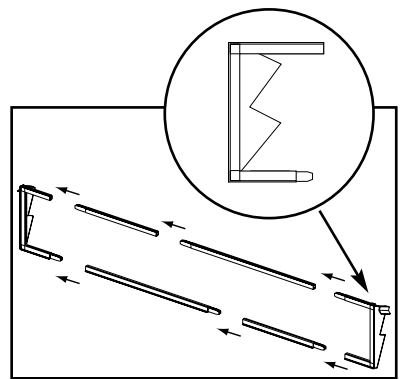

Remove end pieces from box. Lay end pieces opposite each other. Place segments in between, all ends should match up male to female.

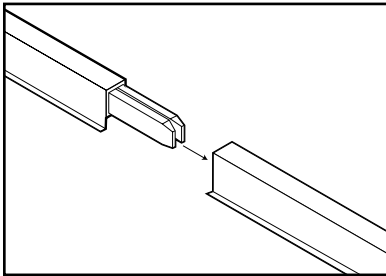

Starting with an end piece connect all pieces together.

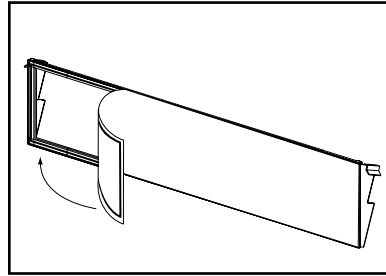

Unroll graphics and attach to front of bridge frame. Press to adhere Velcro ends.

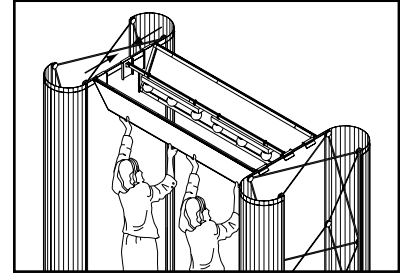

We recommend that two people lift and hang each half of the bridge. Hook bridge on bridge braces. Slide both halves of the bridge together and press to adhere Velcro edges.

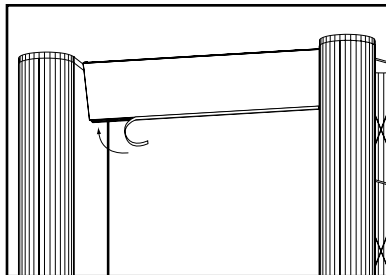

Attach the triangular bridge fabric panel to the underside of the bridge.

# 125" Triangular Bridge Stabilizer Instructions

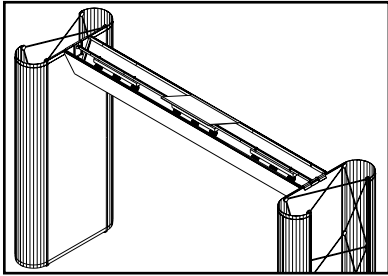

Attach one side of the top stabilizer panel to the top center of the bridge frame.

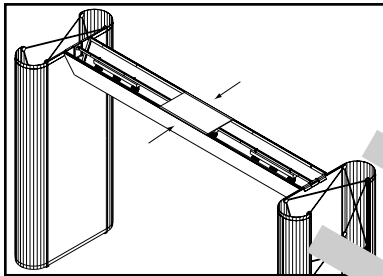

Lift stabilizer panel up and over the top of the bridge frame. Squeeze frames together to secure attachment to the opposite side of the bridge.



# Bridge (cont.)

Install the Bridge Brace appropriate to the position of your Bridge

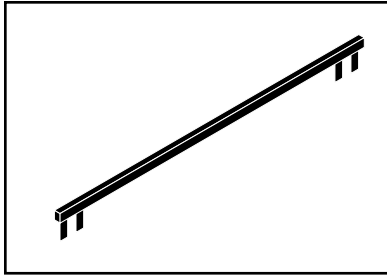

15"/0.38m or 30"/0.76m Bridge Brace

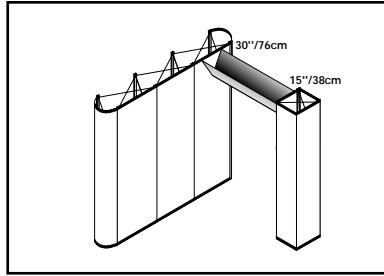

Bridge off top front of frame.

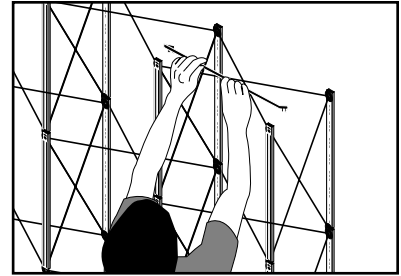

Insert the 15"/0.38m or 30"/0.76m bridge brace securely into the slots at the top of the connected struts.

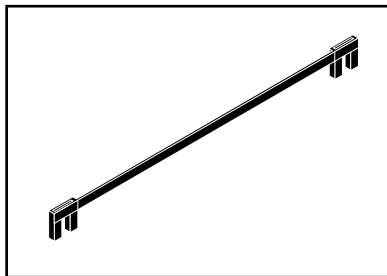

30"/0.76m Halogen Light Bridge Hanger Bar

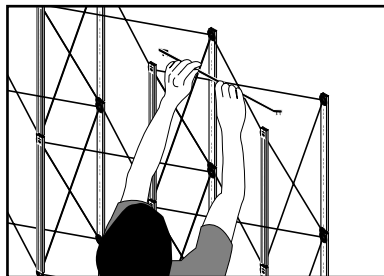

Insert the 15"/0.38m or 30"/0.76m halogen light bridge brace securely into the slots at the top of the connected struts.

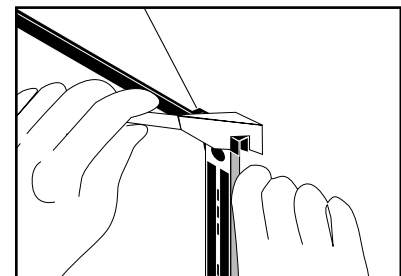

Slide base of halogen light onto each end of the halogen light bridge brace. Swivel light fixtures to adjust position.

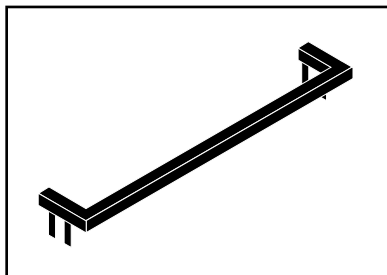

15"/0.38m 90° Bridge Brace

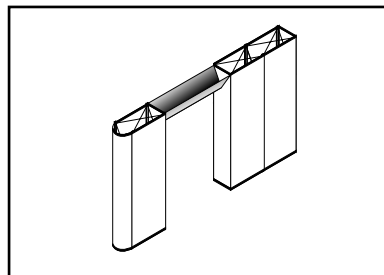

Bridge off top side of frame.

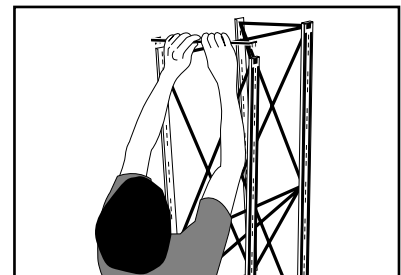

Insert the 15"/0.38m 90° bridge brace securely into the slots at the top of the connected struts.

# Bridge (cont.)

Install the Bridge Brace appropriate to the position of your Bridge

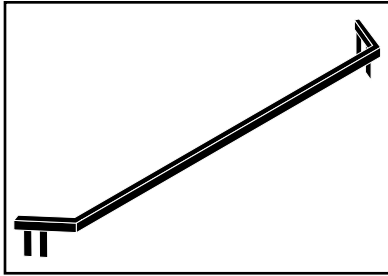

30"/0.76m 45° Bridge Brace

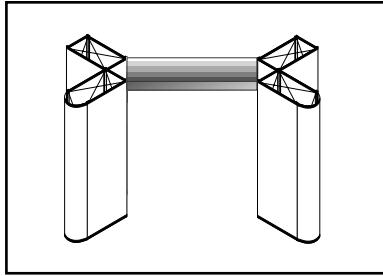

Bridge off top corners of two frames.

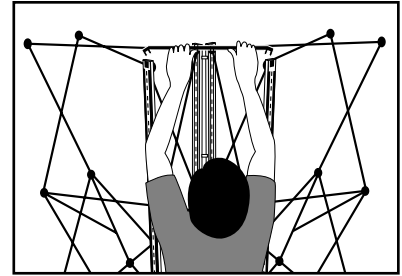

Insert the 30"/0.76m 45° bridge brace securely into the slots at the top of the connected struts.

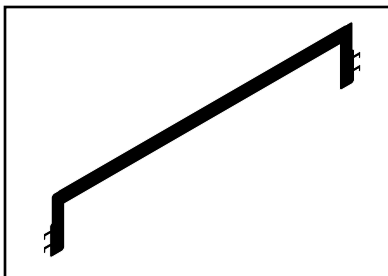

30"/0.76m Mid-Level Bridge Brace  
--Front Position

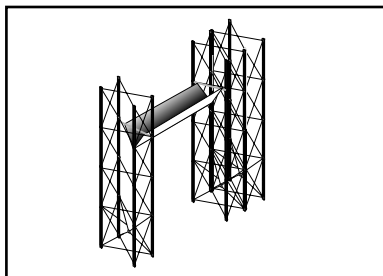

Bridge off middle front of Tower frame.

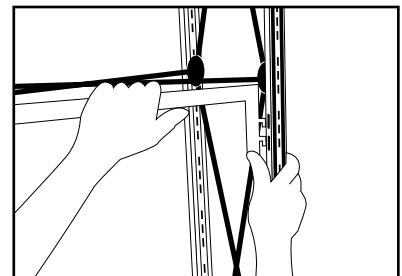

Insert the mid-level bridge brace securely into the side of the connected struts.

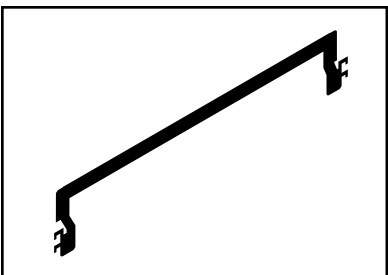

15"/0.38m or 30"/0.76m Mid-Level Bridge Brace--Side Position

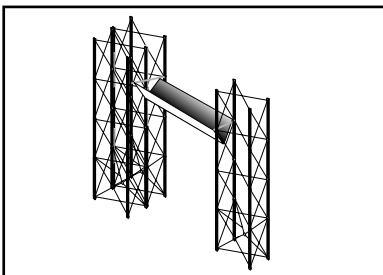

Bridge to middle side of Back-to-Back Tower frame to middle side of plus frame.

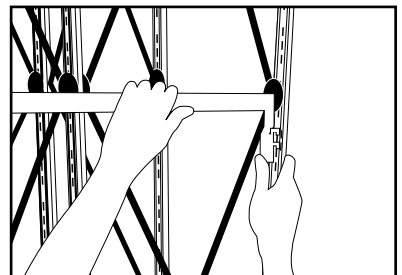

Insert the mid-level bridge brace securely into the connected struts.

# Bridge Hanging and Backlighting

*Fluorescent Lights are UL or ETL approved*

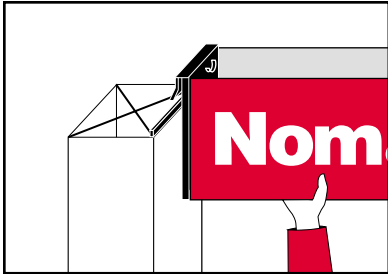

Hook bridge onto bridge braces between two displays or a display and column.

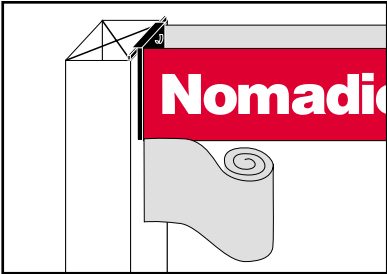

Apply bridge diffuser panel to underside of square bridge.

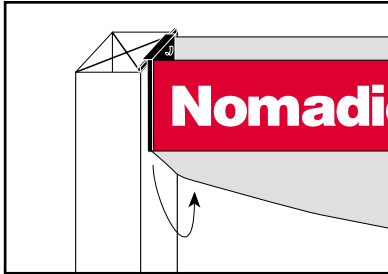

Fold across and apply second side.

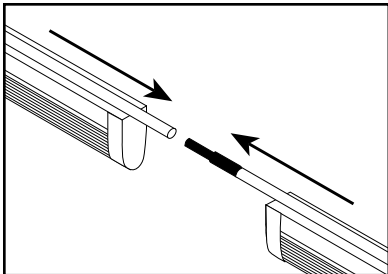

Connect fluorescent light fixtures by joining sections.

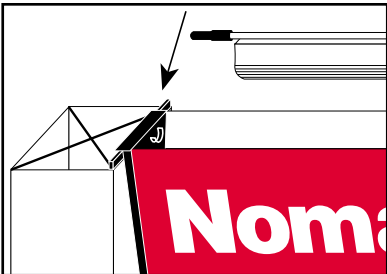

Place fluorescent lights inside bridge cavity. Set light onto cup located in each end plate.

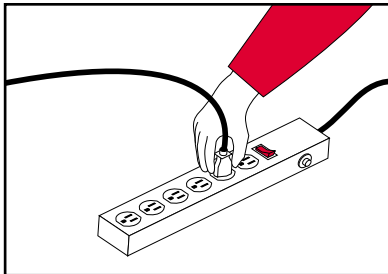

Plug light cords into ElectroStrut at the back of the frame.

# Extended Quad

*Fluorescent Lights are UL or ETL approved*

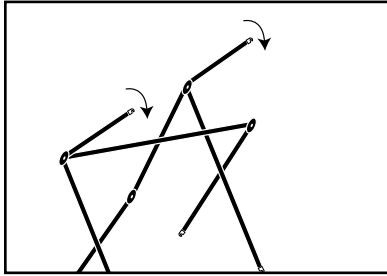

Unfold and lock extended quad frame by sliding hook ends into slots located in front hubs.

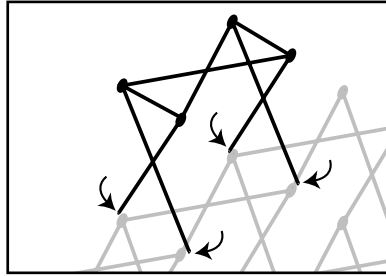

Place frame in position. Slide hook ends of frame into slots located in front and back hubs.

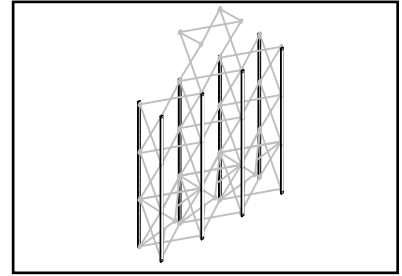

Attach connected struts on entire system.

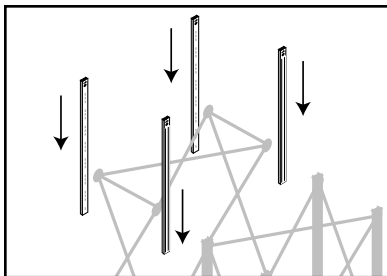

Slide extended quad struts onto all four sides.

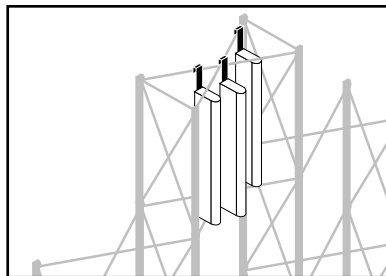

Hang optional fluorescent lights from back scissor of frame.

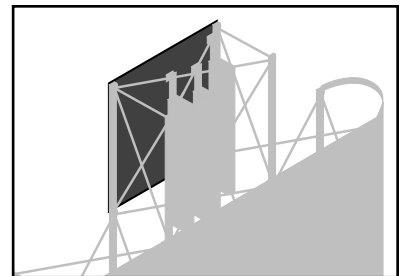

Hang panel on back of extended quad frame.

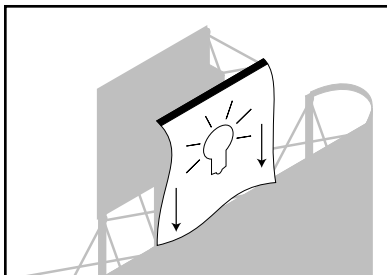

Hang transparency to front of extended quad frame and tuck bottom behind lower panel.

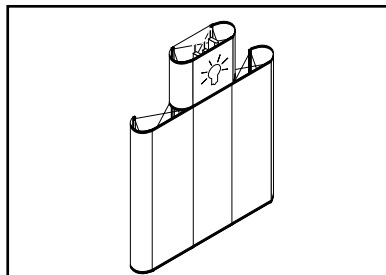

Hang end caps on sides.

**CAUTION –**  
Some parts on rods may be sharp; please handle with care.

# External Shelves and Waterfall Bracket

## Plus and Classic External Shelves

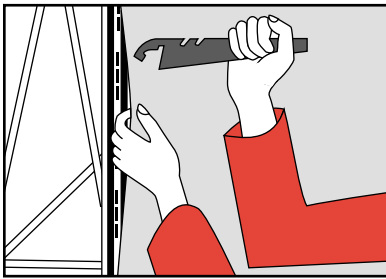

Remove brackets from CareKit. Gently pull panel away from bottom of frame. Count slots in strut to select shelf height. Insert bracket into slotted strut.

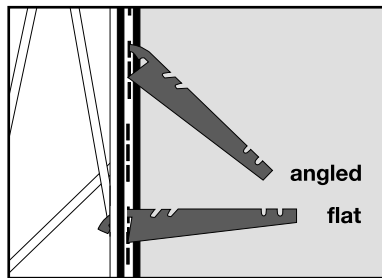

Brackets install two ways. Place brackets in first position for angled shelving or second position for flat shelving. Brackets rest between magnets and against struts.

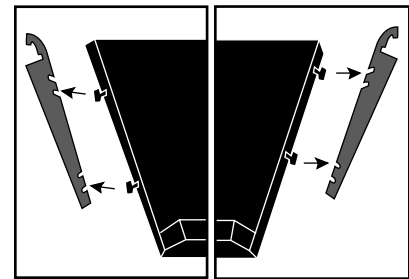

External shelf pegs are offset. Place the back peg into the back slot...

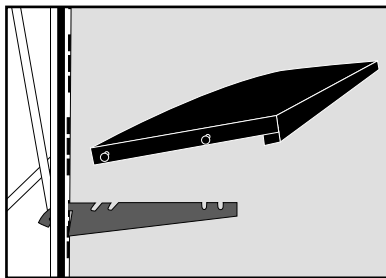

...begin with back shelf pegs, then fit front pegs.

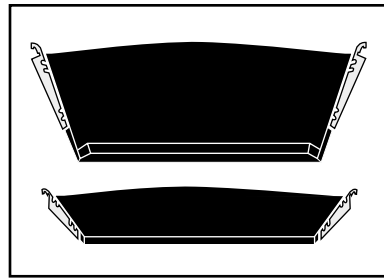

Reversible shelf top has ledge on one side and smooth plane on other. For continuous flat shelving, shelf tops rest on shared bracket. Shelf load 20 lbs / 9 kg maximum; heavier load may cause failure.

**CAUTION –**  
Do not use external shelves on Plus backwalls without wings.

Do not use external shelves on Classic frames less than three quads wide.

## Waterfall Bracket

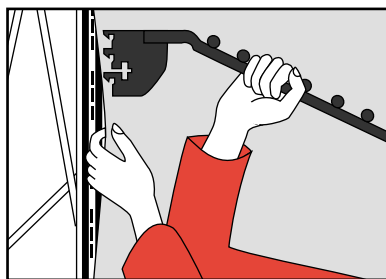

Gently pull panel away from bottom of frame. Select bracket height. Insert bracket into slotted strut.

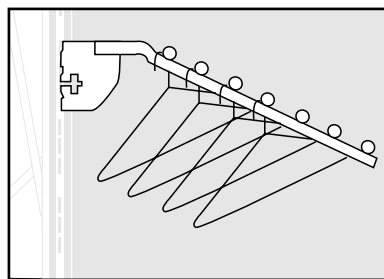

Waterfall bracket load is 20 lbs / 9 kg maximum; heavier load may cause failure.

# Plus One Quad ShowCase and Pass Through Box

*Halogen Downlights are UL or ETL approved*

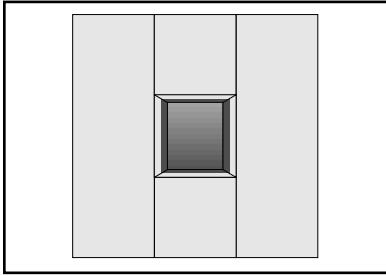

Plus frames accept one quad ShowCase in any quad without crossbracing.

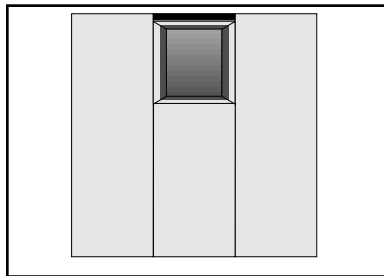

Top level installation is also possible.

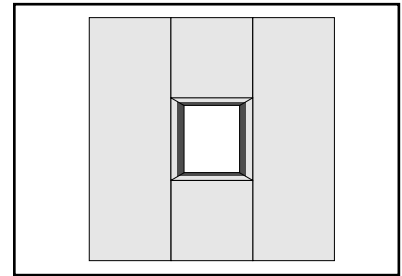

Plus frames accept pass through box in any quad without crossbracing.

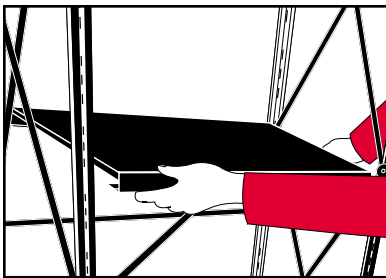

Press shelf down onto frame scissor. Maximum shelf load is 50 lbs / 23 kg; heavier load may cause failure.

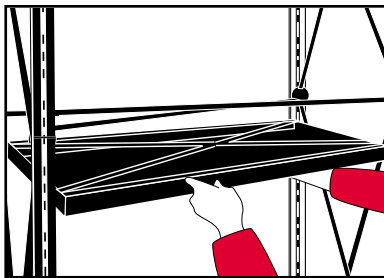

Press top panel up onto underside of scissor until it clips.

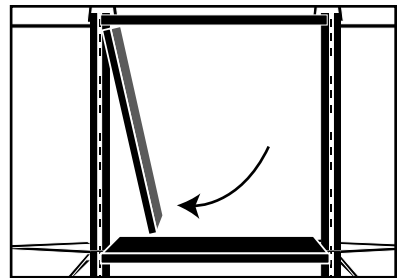

Press side panels into place.

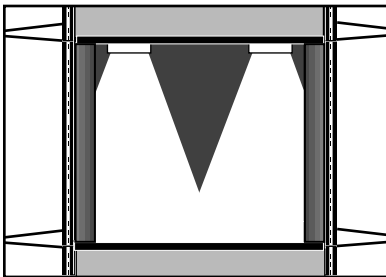

Halogen downlights are built-in. Hang backdrop fabric panel on backside of frame for ShowCases.

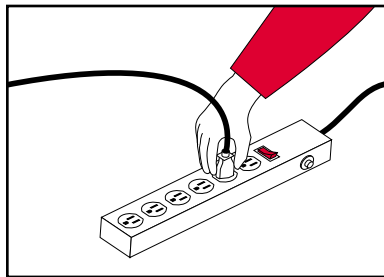

Plug light cords into ElectroStrut power outlet strip. Use power switch to turn all Lights on and off.

20 Watt halogen bulb replacements are available at most lighting and hardware stores. To insure long bulb life, do not touch bulb with fingers.

**CAUTION –**  
Fixtures become hot with use — handle with care.

In North America order 1 Amp of single phase 120v electrical service for 5 Ball Lights

Use a maximum of 20 watt bulbs if replacement is necessary.

# Plus One Quad ShowCase and Pass Through Box

*Halogen Downlights are UL or ETL approved*

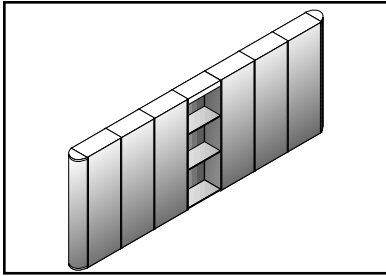

Plus frames accept multiple one quad ShowCases in a single frame or between frames with plus to plus connecting scissors.

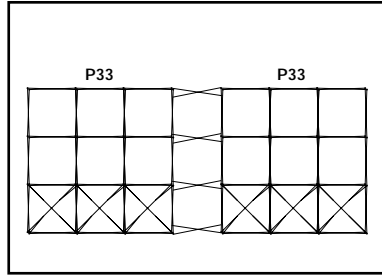

Place frames side-by-side and unfold connecting scissors carefully. Attach 4 connecting scissors.

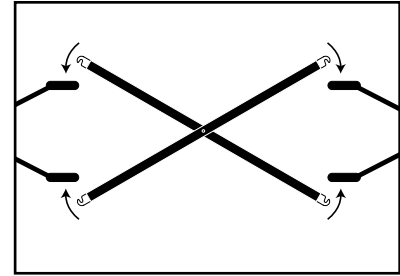

Slide hooked blade ends of connecting scissor into slots located in front and back hubs.

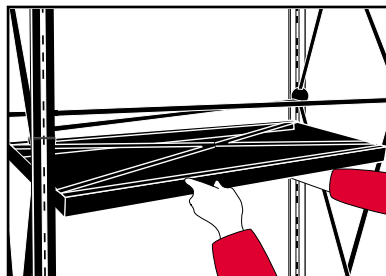

Working from floor upwards, press the top panel up onto underside of each scissor until it clips. Run power cord out the side.

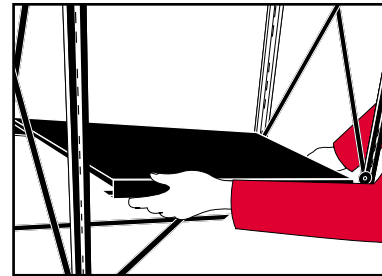

Working from floor upwards, place shelf down onto each scissor. Maximum shelf load is 50 lbs / 23 kg; heavier load may cause failure.

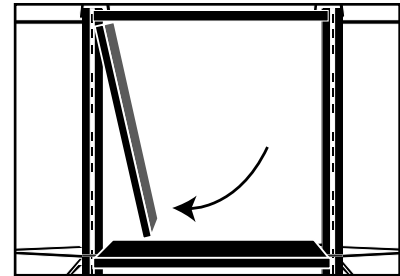

Insert side panels into place. Repeat steps for remaining quads.

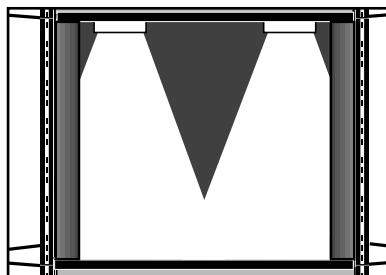

Halogen downlights are built-in. Hang backdrop fabric panel on backside of frame for ShowCases.

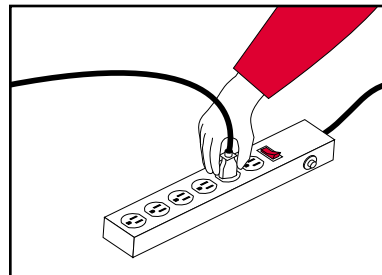

Plug light cords into ElectroStrut power outlet strip. Use power switch to turn all lights on and off.

## CAUTION –

Some parts on scissors and rods may be sharp; please handle with care.

Fixtures become hot with use — handle with care.

Use a maximum of 20 watt bulbs if replacement is necessary.

In North America order 1 Amp of single phase 120v electrical service for 5 Ball Lights

20 Watt halogen bulb replacements are available at most lighting and hardware stores. To insure long bulb life, do not touch bulb with fingers.

# Plus 1½ or 2 Quad ShowCase with or without Lights

*Halogen Downlights are UL or ETL approved*

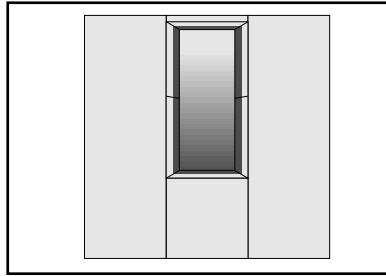
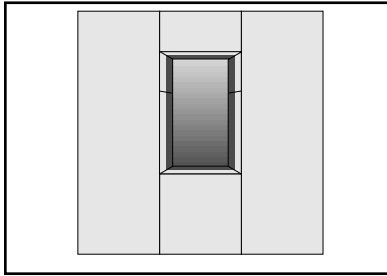

## CAUTION –

Some parts on scissors and rods may be sharp; please handle with care.

Fixtures become hot with use — handle with care.

**Use a maximum of 20 watt bulbs if replacement is necessary.**

\*To install either the one-and-one-half quad or the two-quad ShowCase your plus frame must be manufactured with manual locks. It can also be installed between two frames using the plus to plus connecting scissors. See special frame set-up instructions below.

### \*Manual frame set-up

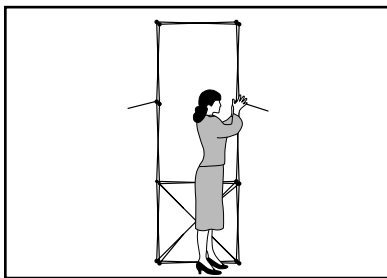

Unfold frame and...

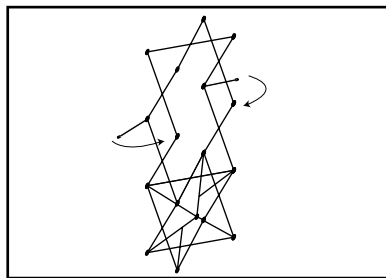

Lock by sliding hook ends into slots located in front hubs.

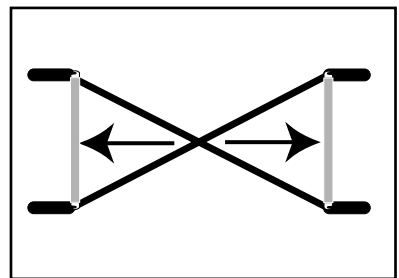

Some frames require removable manual locks. Slide hooked blade ends of removable manual locks into slots of hub just above frame scissors on inside of frame.

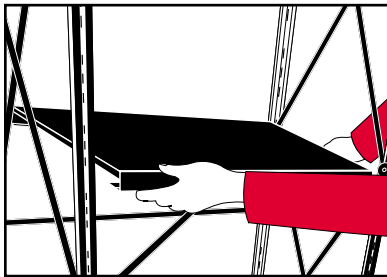

Press shelf down onto frame scissor. Maximum shelf load is 50 lbs / 23 kg; heavier load may cause failure.

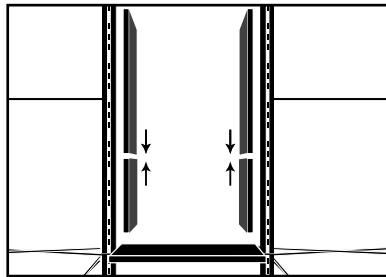

Slide the parts of the side panels together with the shorter piece on the bottom in each case.

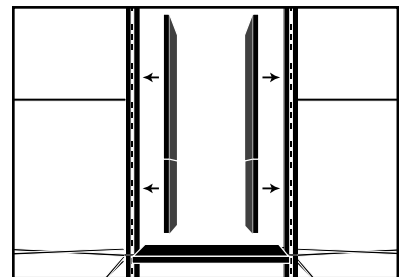

Press the joined side panel sections into position.



# Plus 1<sup>1</sup>/<sub>2</sub> or 2 Quad ShowCase with or without Lights

*Halogen Downlights are UL or ETL approved*

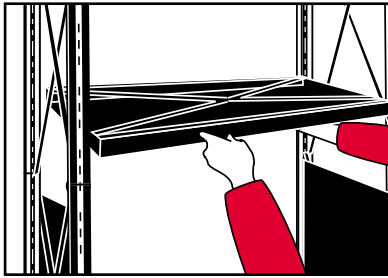

Rest top panel on side panels.

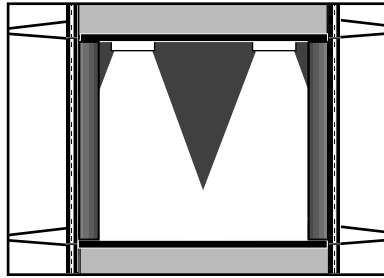

Halogen downlights are built-in. Hang backdrop fabric panel on backside of frame.

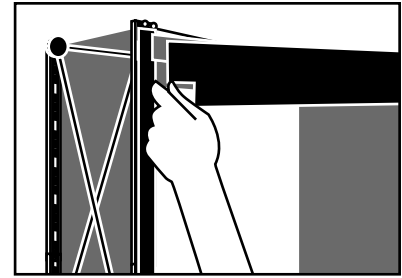

For two-quad high ShowCase, hang top quad plus filler panel and slide panel into top lip of ShowCase.

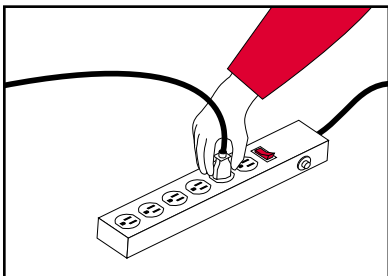

Plug light cords into ElectroStrut power outlet strip. Use power switch to turn all Lights on and off.

In North America order 1 Amp of single phase 120v electrical service for 5 Ball Lights

20 Watt halogen bulb replacements are available at most lighting and hardware stores. To insure long bulb life, do not touch bulb with fingers.

# ShowCase Accessories

## Adjustable Acrylic Shelves

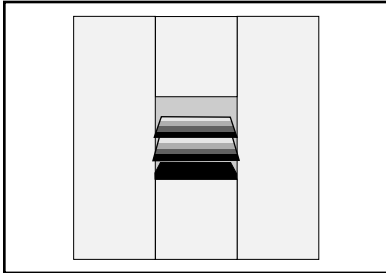

To install Acrylic shelves, the side panels of your ShowCase must have pegs.



Place clear acrylic shelf on side panel pegs.

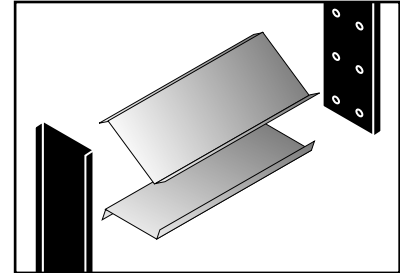

Shelves may be installed flat or on an angle. Shelf load 11 lbs / 5 kg; maximum heavier load may cause failure.

## ShowCase Shelf Extension Bracket



Gently pull panel away from bottom of frame. Count down 2 slots from ShowCase bottom. Insert bracket into slotted strut.

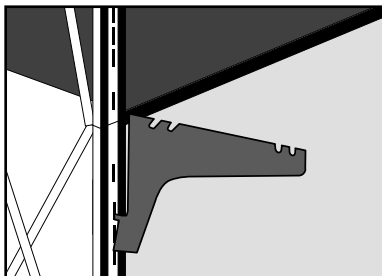

Brackets rest between magnets and against struts.

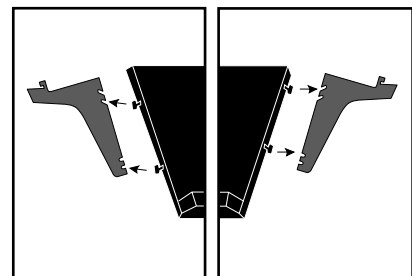

External shelf pegs are offset. Place the back peg into the back slot...

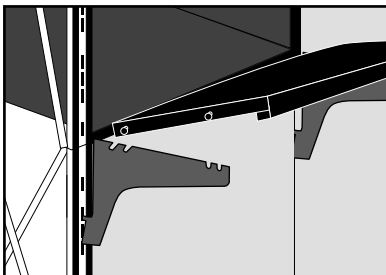

...begin with back shelf pegs, then fit front pegs.

Reversible shelf top has ledge on one side and smooth plane on other. For continuous flat shelving, shelf tops rest on shared bracket. Shelf load 20 lbs / 9 kg maximum; heavier load may cause failure.

**CAUTION –**  
Do not use external shelves on Plus backwalls without wings.

Do not use external shelves on Classic frames less than three quads wide.

# Monitor Shelf

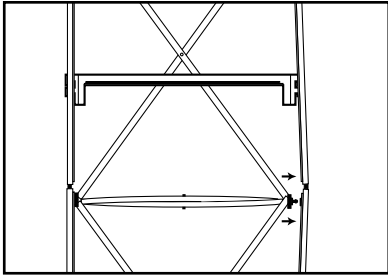

Count slots in strut to select height. Unsnap strut from closest stud.

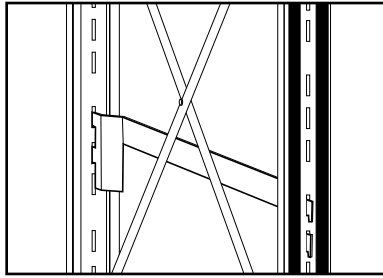

Bridge bracket between two slotted struts, the edge with the lip should face interior quad. Make sure bracket is seated. Resnap strut.

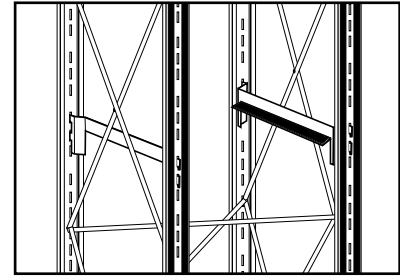

Insert other bracket at same slot height on the opposite side of the quad.

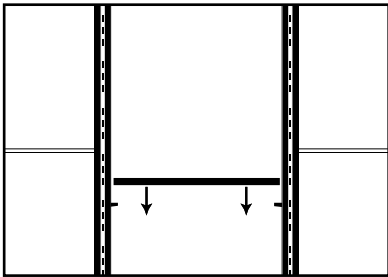

Remove shelf from case. Center shelf on the bracket edges, pegs facing down. Guide pegs into holes on lip of bracket.

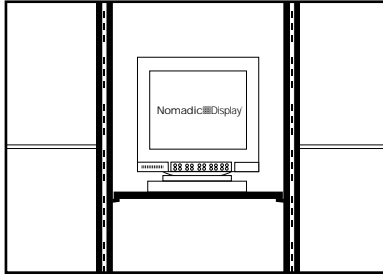

Shelf load 100 lbs / 46 kg maximum; heavier load may cause failure.

## WARNING:

Caution should be taken with frames containing multiple Monitor Shelves.

# DemiTable with Fabric or Backlit Graphics

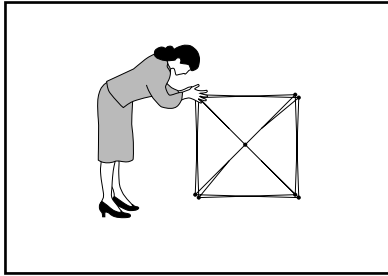

Set up DemiTable Frame.

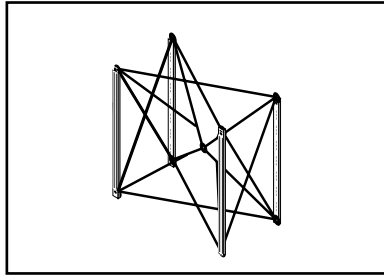

Attach table struts to all sides of frame.

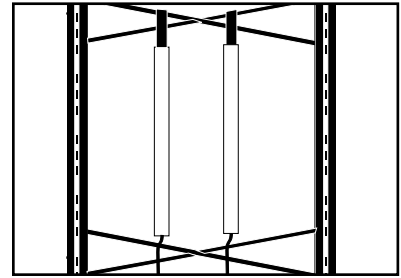

For backlit graphics, suspend fluorescent light from back scissor above the quad.

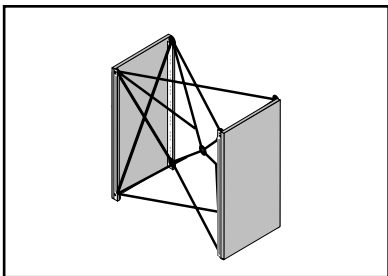

Attach table side to each end of table frame.

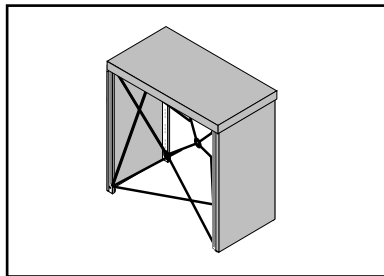

Press DemiTable top shelf down onto frame scissors, ensuring that snap clips are engaged. NOTE: Maximum load is 50 lbs / 23 kgs; heavier load may cause failure.

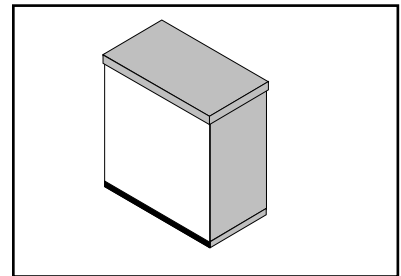

Hang bottom quad plus fabric panels or graphic panels to front and rear of table.

# Peninsula Table with Fabric or Backlit Graphics

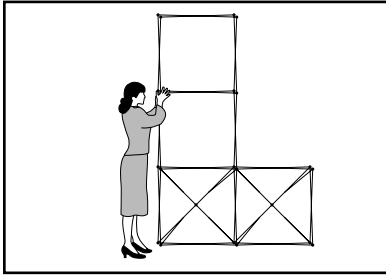

Set up Peninsula Frame.  
P31P1 8'x5' / 2.4 x1m (bottom)

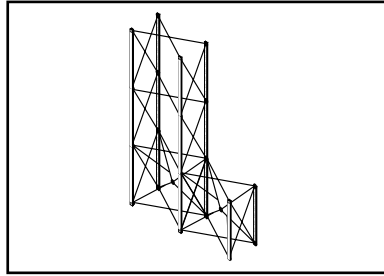

Attach connected struts to all sides of frame.

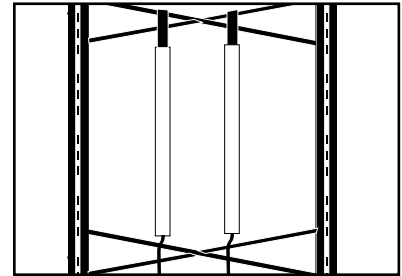

For backlit graphics, suspend fluorescent light from back scissor above the quad.

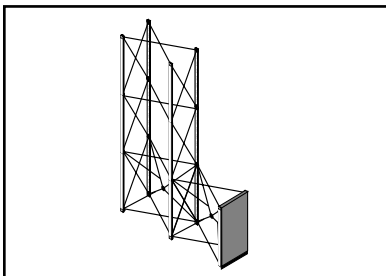

Attach table side panel to end.

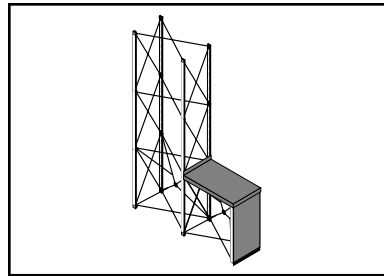

Press Peninsula Table top shelf down onto frame scissors, ensuring that snap clips are engaged. NOTE: Maximum load is 50 lbs / 23 kgs; heavier load may cause failure.

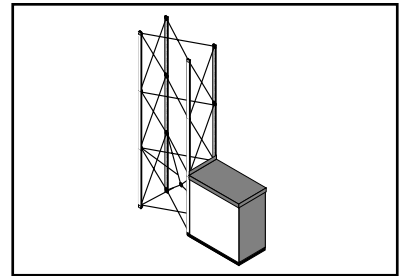

Hang bottom quad plus fabric panels or graphic panels to front and rear of table.

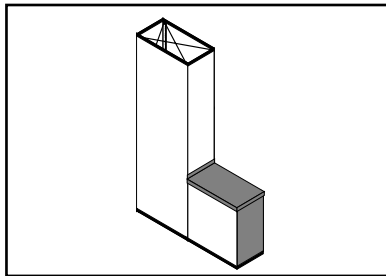

Add fabric panels or graphic panels to remainder of display.

If your Peninsula Table is attached to another frame, see Frame Connection Section for appropriate method.

# Rolluxe Pedestal

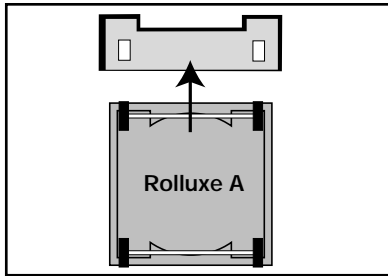

Place one wheel stop on the floor and roll the case onto it.

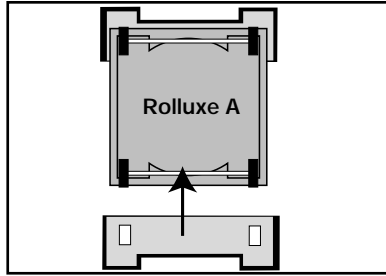

Place second wheel stop on the floor under the opposite wheels.

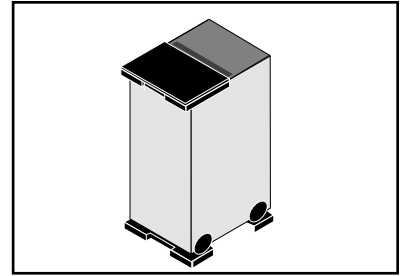

Place the plastic top shelf half with exposed magnetic lip on top of the case.

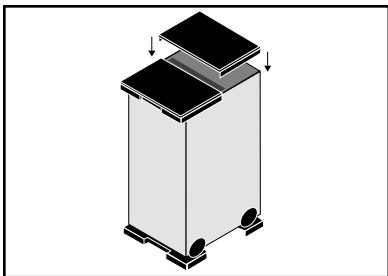

Place the second plastic top shelf half on top of the case, ensuring magnets are aligned and engaged.

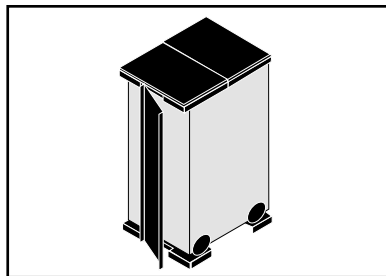

Attach front fabric panel to Velcro® at top and bottom. Form a straight line with magnets on front panel before attaching end caps.

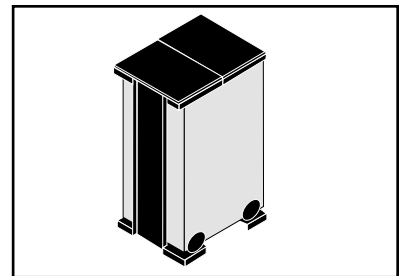

Repeat on opposite side.

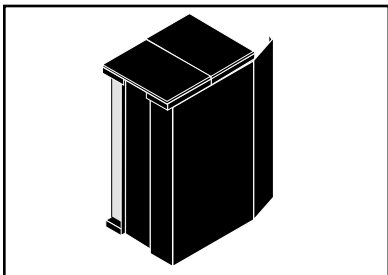

Attach fabric end cap by starting at corner...

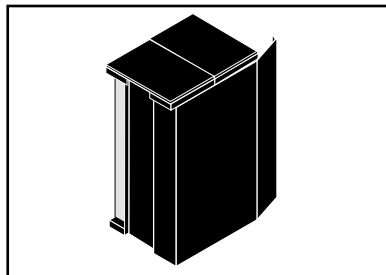

...wrap end along top edge then bottom edge. Slide hands along length of edge of end cap to bond magnets.

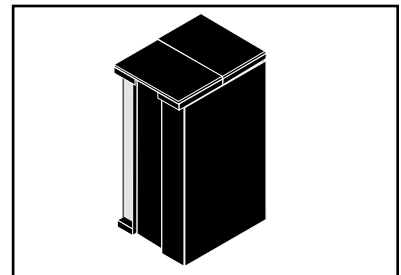

Repeat with last end cap. Pedestal load is 100 lbs / 46 kg; heavier load may cause failure.

# Rolluxe Counter

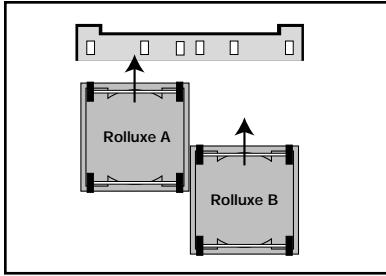

Place one wheel stop on the floor and roll the cases on to it.

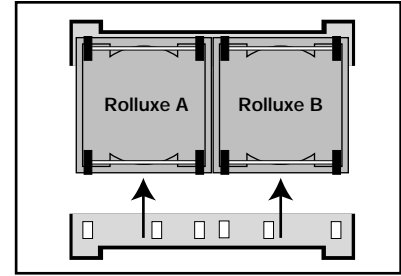
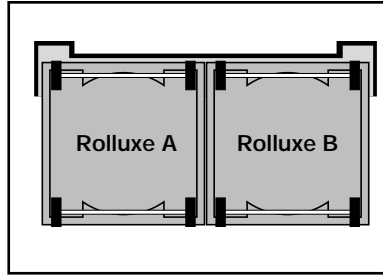

Place second wheel stop on the floor under the opposite wheels.

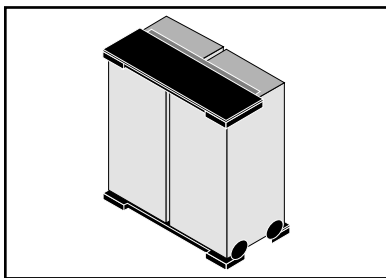

Place the plastic top shelf half with exposed magnetic lip on top of the case.

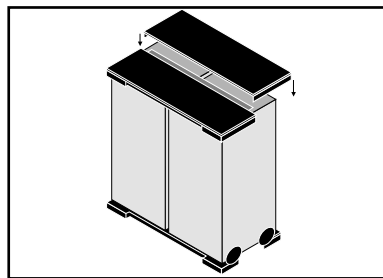

Place the second plastic top shelf half on top of the cases ensuring magnets are aligned and engaged.

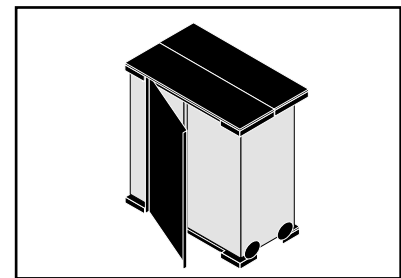

Attach front fabric panel to Velcro® at top and bottom. Form a straight line with magnets on front panel before attaching end caps.

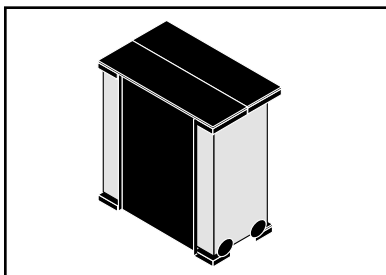

Repeat on opposite side.

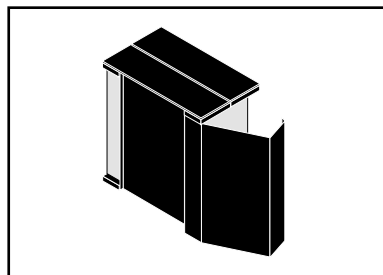

Attach fabric end cap by starting at corner...

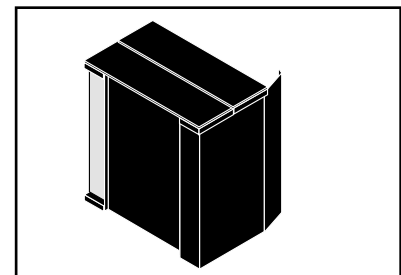

...wrap end cap along top edge then bottom edge. Slide hands along length of edge of end cap to bond magnets.

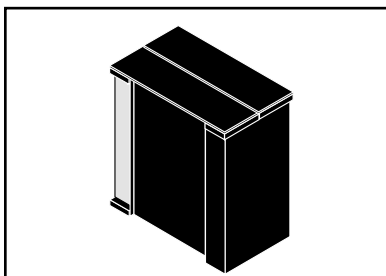

Repeat with last end cap. Counter load is 100 lbs / 46 kg; heavier load may cause failure.

# RollEase Counter

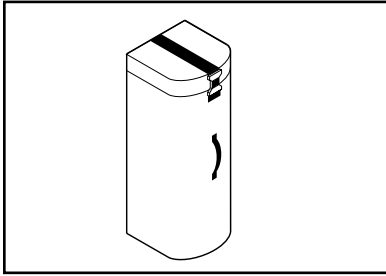

Remove all components in MailBox case and place the lid inside the empty case. Place MailBox case inside one of the empty RollEase cases.

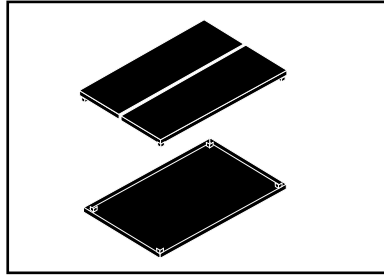

Unfold the counter top and bottom shelf and place on floor.

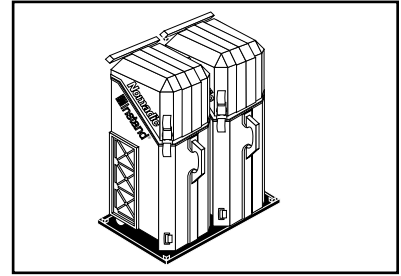

Place RollEase cases side by side on the bottom shelf.

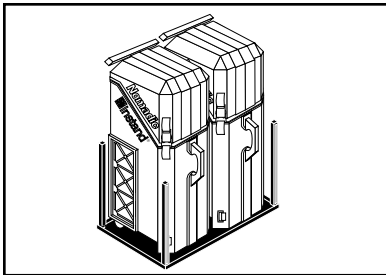

Insert bottom legs (with "down" label) into corner guides. Magnetic strips must face out on long side of counter.

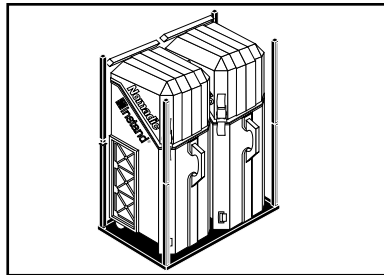

Remove the top legs from the top shelf and insert into the bottom legs. Align magnetic strips.

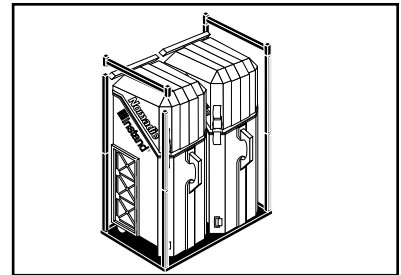

Connect top legs with "H" bars on short side of counter.

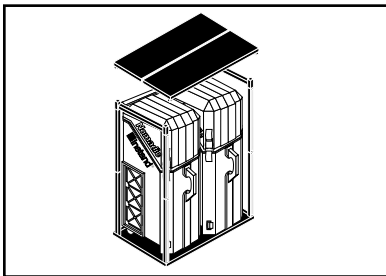

Place top shelf onto "H" bars guiding them into corner guides.

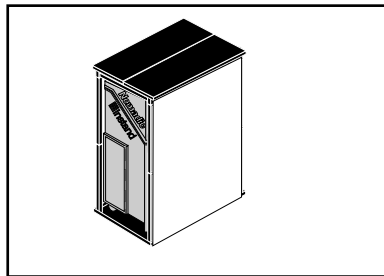

Hang fabric panels on the front and back of counter by squaring top edges and adhering the side edges to magnetic strips along the legs. Push fabric against Velcro® on top and bottom edges to secure.

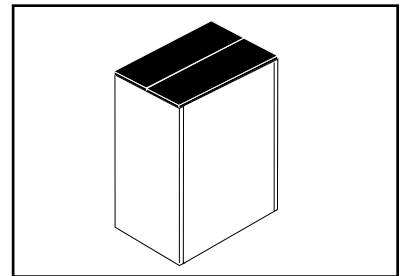

Hand crease hinges on fabric end caps. Hang both end caps by squaring the top edges with the top shelf, then folding the side edges to adhere to the magnetic strips along the legs. Counter load is 60 lbs / 28 kg; heavier load may cause failure.



# FabriCounter

*FabriCounter is UL approved*

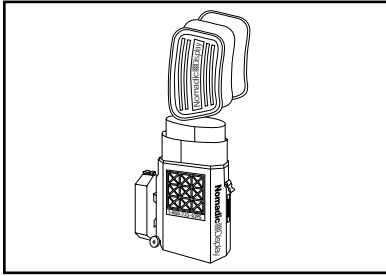

Unpack contents of case...

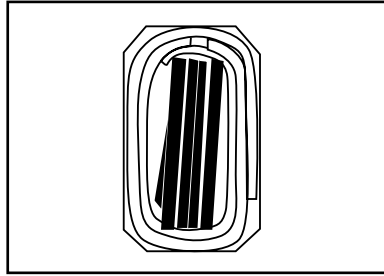

...upper fabric panel, lower fabric panel and shelves.

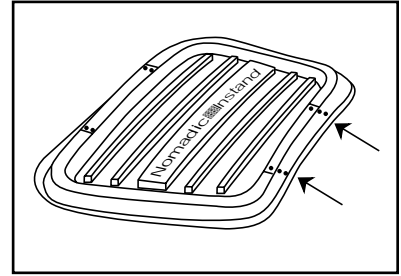

Place bottom shelf on floor with ridges up. Begin at alignment points...

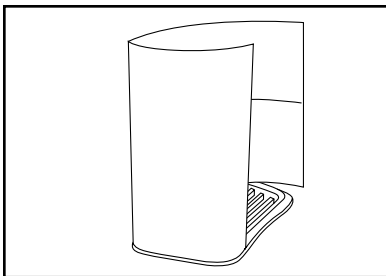

...insert lower fabric panel (seam inside) into base. Guide panel into outside groove. Press firmly into place.

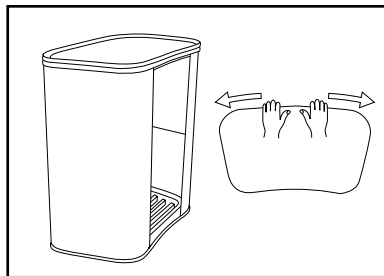

Place middle shelf on top. Guide panel into the underside groove. (Snap on top shelf to convert to a table.)

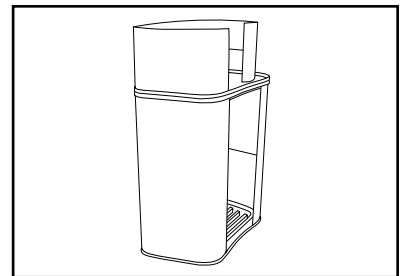

Insert upper fabric panel into top of middle shelf. Guide panel into outside groove.

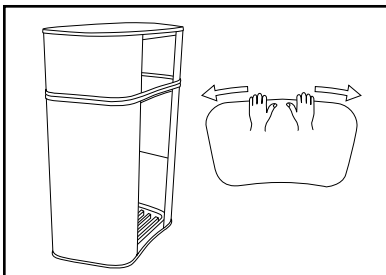

Snap on the top shelf. Guide upper fabric panel into underside groove. Repack according to first two illustrations. Maximum load is 40 lbs / 18 kg; heavier load may cause failure.

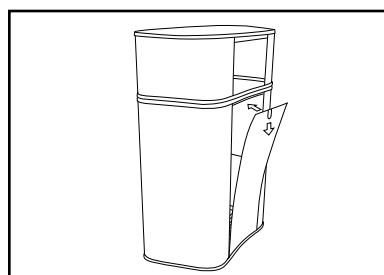

FabriCounter/Lectern Fabric Door (optional accessory). Insert door into groove of bottom shelf with pull-tab outward. Flex door and tuck it into groove along the underside of middle shelf. To open door, simply pull downward on tab.

# Lectern

*Lectern is UL approved*

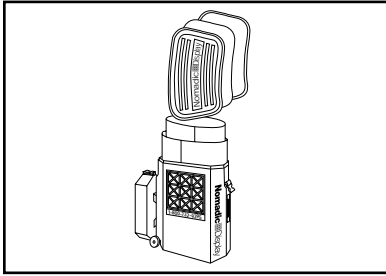

Unpack contents of case...

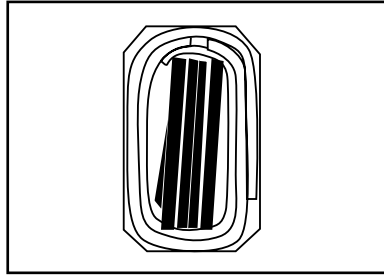

...upper fabric panel, lower fabric panel and shelves.

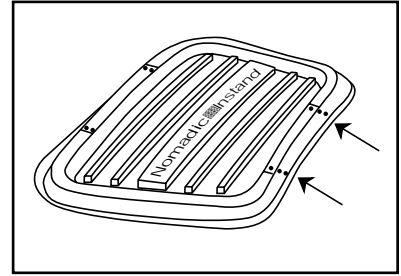

Place bottom shelf on floor with ridges up. Begin at alignment points...

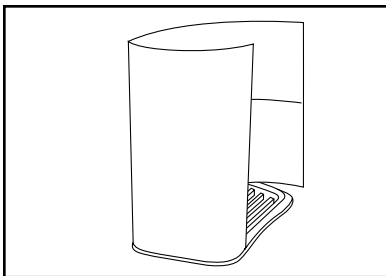

...insert lower fabric panel (seam inside) into base. Guide panel into outside groove. Press firmly into place.

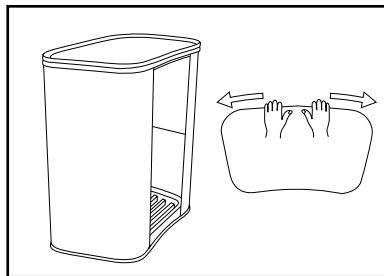

Place middle shelf on top with the ridges towards the floor. Guide panel into the underside groove.

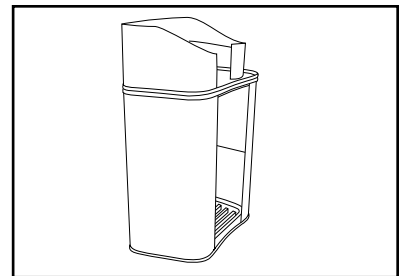

Insert upper fabric panel into top of middle shelf. Guide panel into outside groove.

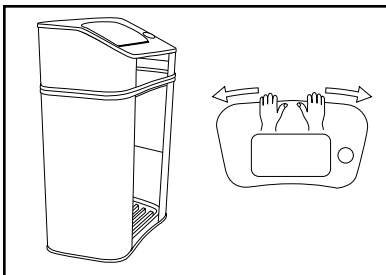

Press on the top. Guide small panel into underside groove. Repack according to first two illustrations.

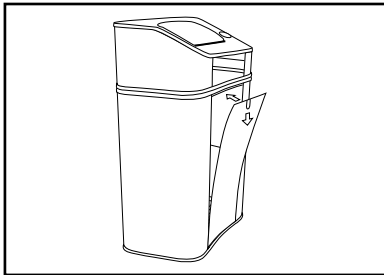

FabriCounter/Lectern Fabric Door (optional accessory). Insert door into groove of bottom shelf with pull-tab outward. Flex door and tuck it into groove along the underside of middle shelf. To open door, simply pull downward on tab.

# Dismantling Instructions

Remove all accessories:

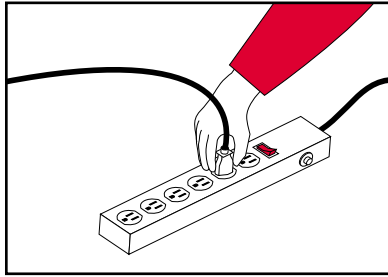

Switch off and unplug all lights. Allow them to cool.

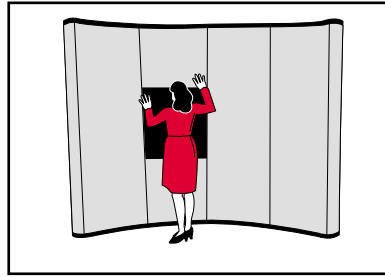

Gently remove and roll up all surface graphics.

Refer to diagrams inside case to repack contents.



Remove shelving, and HeadLiner.

Remove and roll up FabriColor and Photomural Strips:

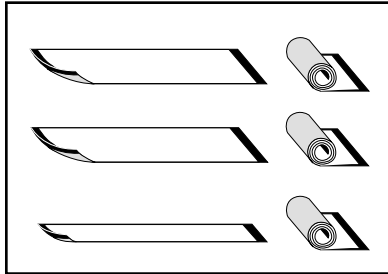

Roll individual **Fronrunner**, **Hero and Showtime** Panels fabric side out. Roll Fronrunner End Caps fabric side out.

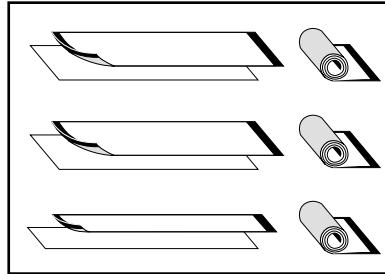

Roll individual **Tempo** fabric or **Photomural** Panels with liners in between and roll fabric/image side out. Repeat same for End Caps.

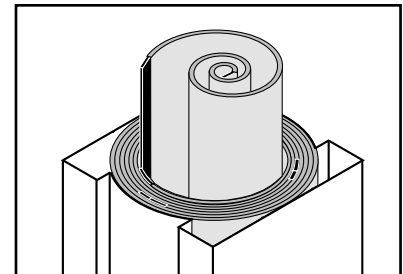

Put rolled panels into case one at a time and one inside another. The top stiffener of one panel should touch the bottom stiffener of the previous panel. Stack Endcaps two high.

Remove Magnetic Struts and Collapse Frames:

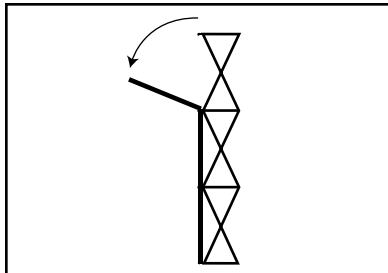

Lift top section of strut up and rotate down. Remove all lights.

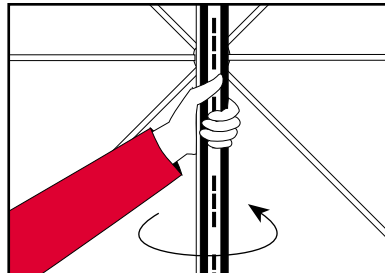

Twist strut to unsnap from frame.

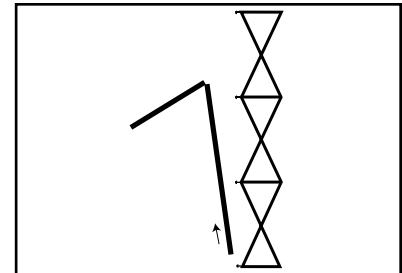

Lift bottom of strut off bottom stud.

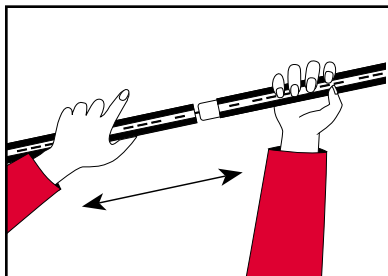

Pull strut sections apart.

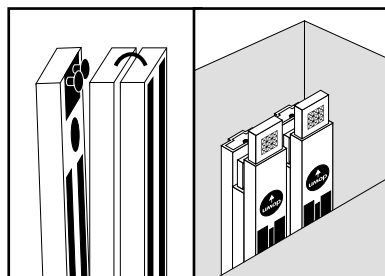

Fold lengthwise ensuring that pegs at top of strut face inward. Place connected struts upside down in case.

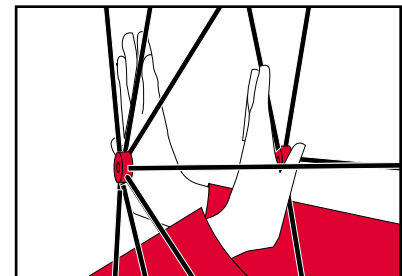

Push on middle hub at back of frame while pushing on corresponding front hub. Instand will sink to the floor. Handle frame at hubs.